

# COLOR VIDEO DOOR PHONE

Model No. CDV-71BE/71BD



## COMMAX Co.,Ltd.

- Thank you for purchasing our COMMAX product.
- Please carefully read this User's Guide (in particular, precautions for safety) before using the product and follow the instructions to use your product exactly.
- The company is not responsible for any safety accidents caused in abnormal operation of the product.

# Warnings and caution

◎ Make sure to follow the instructions to prevent any danger or property losses.



**Warning**  
Death or serious injury is expected.



It indicates prohibition.



It indicates prohibition of disassembly.



It indicates prohibition of contact.



It indicates dos and don'ts.



It indicates that the plug should be pulled out from the socket.



**Warning**

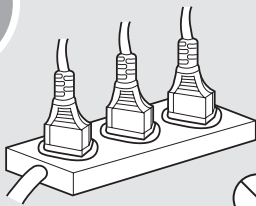

Prohibition

**Do not put the plug in the socket simultaneously.**

It may generate abnormal heat or cause a fire.

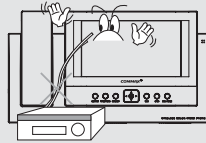

Prohibition

**Do not connect to other products while in use.**

It may cause breakdown.

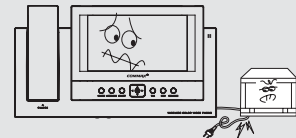

Prohibition

**Do not forcibly bend the cord or put a heavy object on the product.**

It may cause a fire.

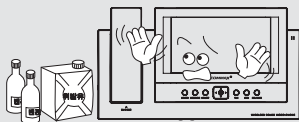

Prohibition

**Do not use water, thinner or a detergent used to wash oil products when you wash the exterior.**

Make sure to wash it by using a dry cloth to prevent any breakdown or electric shock.



Prohibition

**Do not install the product in a humid place.**

It may cause an electric shock or a fire.

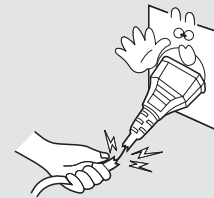

Prohibition

**Do not forcibly pull out the cord from the socket.**

If the cord is damaged, it may cause a fire or an electric shock.

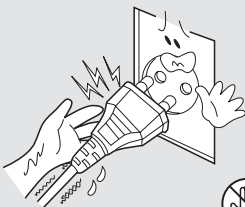

Do not contact.

**Do not put the plug in the socket with a wet hand.**

It may cause an electric shock.

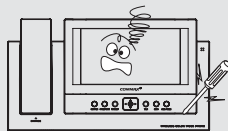

Do not disassemble

**Do not disassemble, repair or modify the product.**

It may cause a fire, an electric shock or an injury due to malfunction of the product.

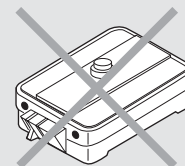

**Do not use AC circuit breaker.**

It may cause an electric shock.

# Warnings and caution



**Caution** An injury or property losses are expected



It indicates prohibition.



It indicates prohibition of disassembly.



It indicates prohibition of contact.



It indicates dos and don'ts.



It indicates that the plug should be pulled out from the socket.



**Caution**

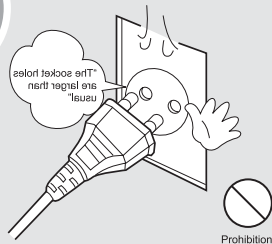

**If the socket holes are larger than normal, do not put the plug.**  
It may cause an electric shock or a fire.

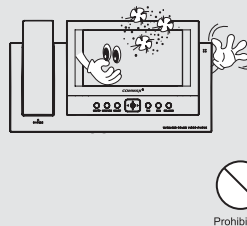

**Make sure that dust or foreign substances are not gathered on the product.**

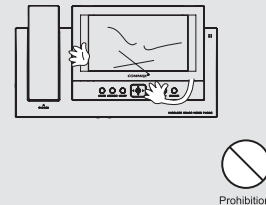

**Make sure to prevent foreign substances from entering the product.**  
It may cause a breakdown.

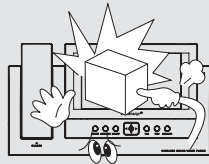

**Do not put a heavy object on the product.**  
It may cause a breakdown.

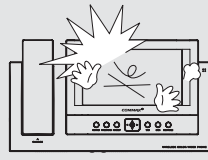

**Do not disassemble or give an impact to the product.**

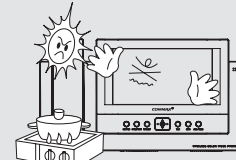

**Avoid direct rays of the sun or heating devices at a time of installation.**

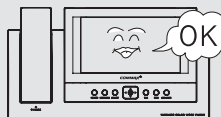

**Install the product in a flat and stable place.**  
Otherwise, it may not function properly.

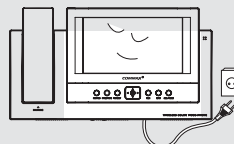

**Pull the plug if the product is not used for a long time.**

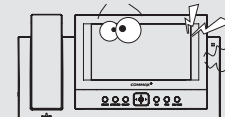

**If the product generates strange sound, make sure to pull the plug immediately and contact Commax service center.**

# Table of contents

1. Name of Parts .....	3
2. Features and Main Function .....	4
3. Package .....	4
4. System Layout .....	5
5. Wiring Diagram .....	6
6. Installation Method.....	7
7. Operating Description .....	8
- Visitor Call & Monitoring	
- Interphone Function	
- Memory Picture (Save visitors pictures, Erase visitors pictures, Time setting)	
- Product setting	
8. Specification .....	12

# 1. Name of parts

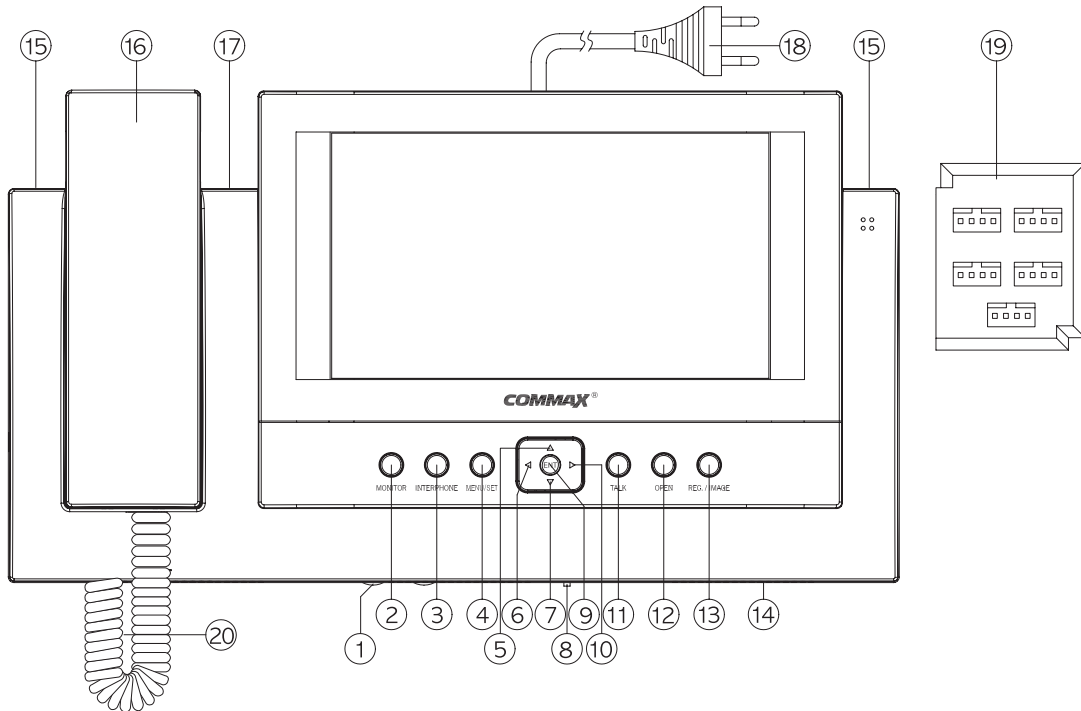

No.	Name	Details
1	Volume for call volume control	Control the call volume
2	Monitor button	View and screen by door camera or talk
3	Interphone button	Talk by interphone between the rooms
4	Open button	Operate on Door release of door camera
5	Up button	Up direction key
6	Left button	Left direction key
7	Down button	Down direction button
8	Power switch	Control the power supply of product
9	Enter button	Execution button
10	Right button	Right direction key
11	REVIEW	Review the stored pictures in memory
12	TIME	
13	REC./DEL.	
14	Speaker	Talk voice and call voice is spoken
15	Mode lamp	Dime lights at night
16	Handset	Hand set
17	Auto memory function	On away mode, a visitor's picture stored in CDV-71BE
18	Power source code(Only CDV-71BE)	Supply power source of product (AC100V-240V Free-voltage)
19	Wiring terminal	Terminal Box for front door camera or interphone.
20	S-cord	

## 2. Features and Main Function

### 1. Features

7" Wide TFT-LCD

Surface mount type installation method

FREE VOLTAGE power supply (CDV-71BD : DC17V~30V)

Menu control by on screen display

### 2. Main function

Communicate between Front door camera and CDV-71BE/D

Interphone call and talk function

Image storing (128 cut) function

Door Open function

CCTV Camera available

4 Door unit & 1 Interphone connectable

## 3.Package

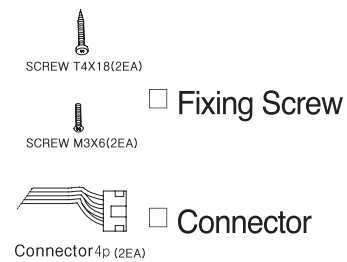
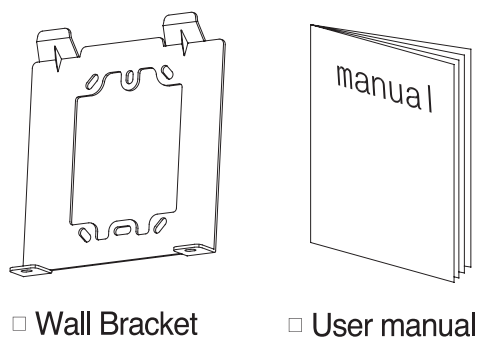
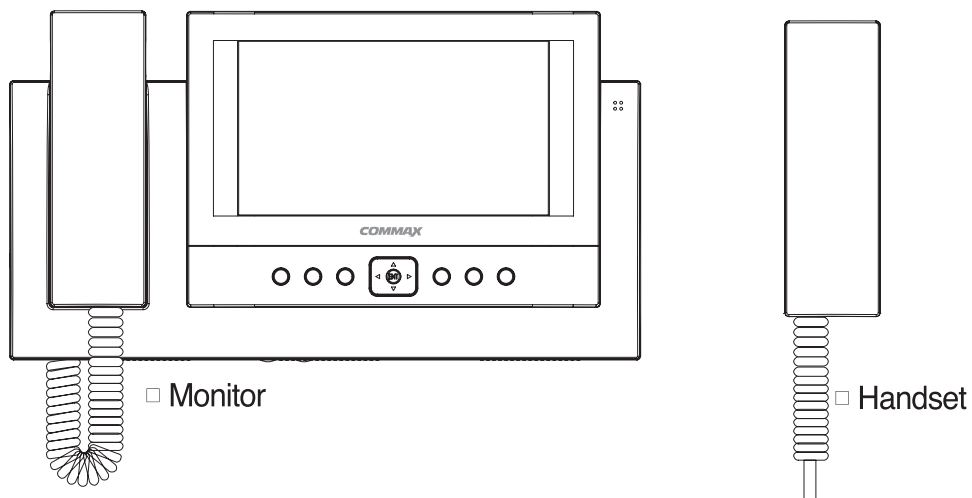

## 4. System Layout

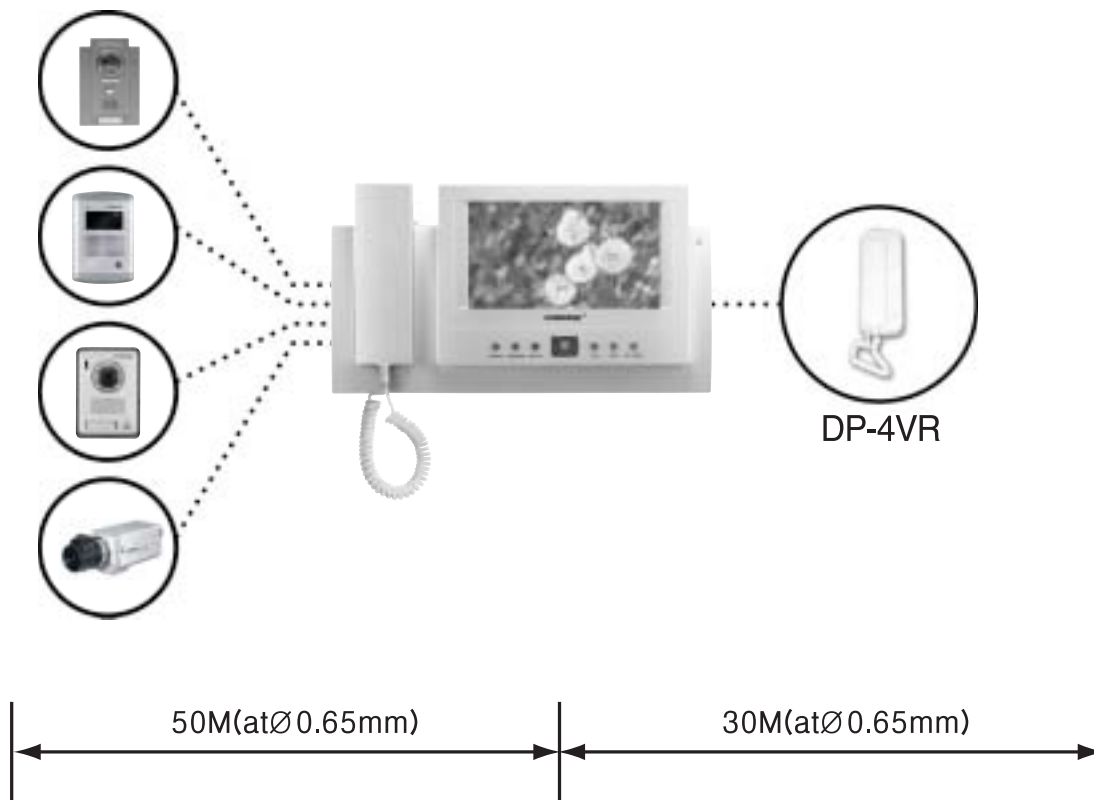

### Sub camera

- Camera: 4 units (Max)   □ CCTV Camera
- Sub phone: 1 unit (DP-4VR)

### Wiring

- Camera : 30M(at Ø0.5mm) / 50M(at Ø0.65mm) / 70M(at Ø0.8mm) / 115M(atØ1.0mm)
- Sub interphone : 30M(at Ø0.65mm) / 50M(at Ø0.8mm)
- CCTV camera : Coaxial Cable

# 5. Wiring Diagram

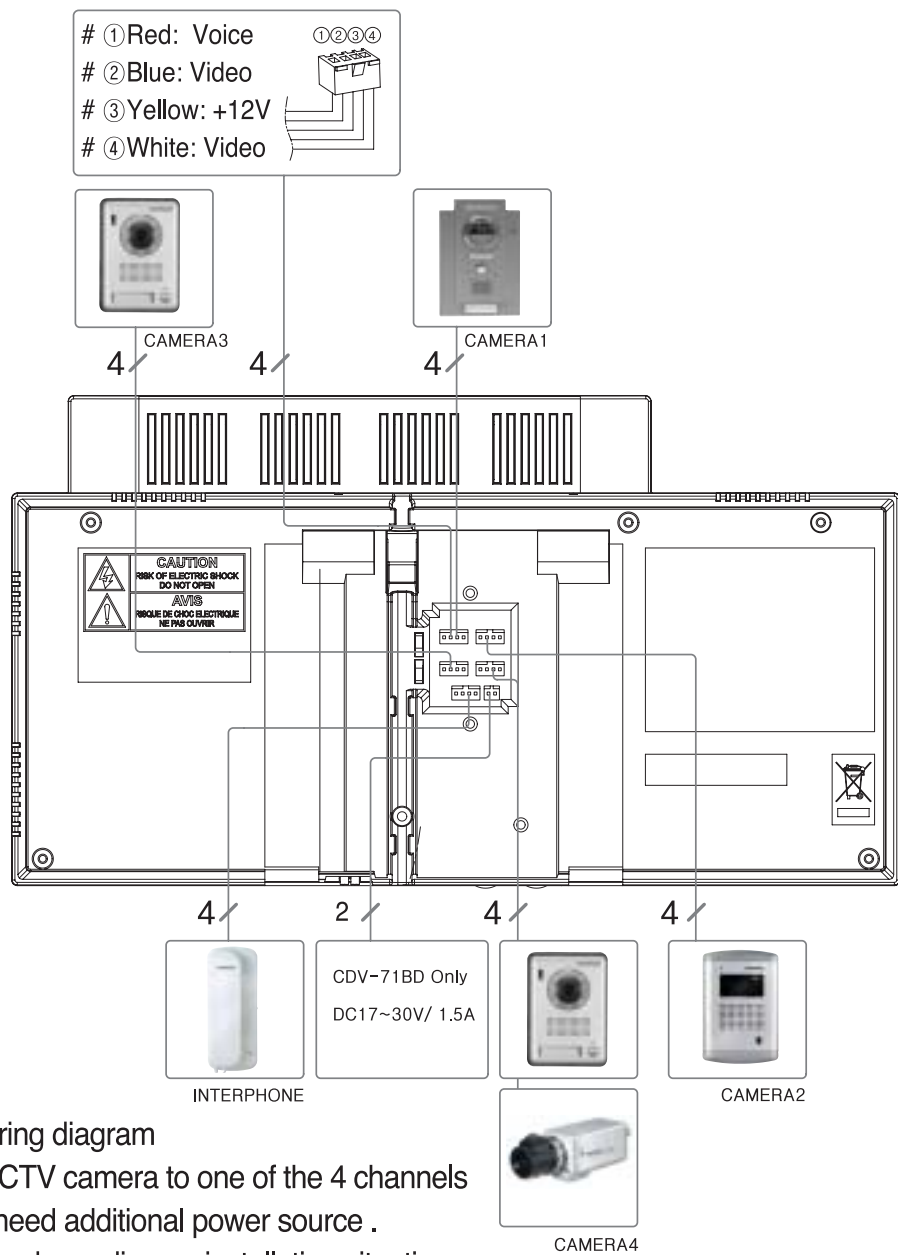

- \* CCTV Camera wiring diagram
- \* Please connect CCTV camera to one of the 4 channels
- \* CCTV CAMERA need additional power source .
- \* Please select wires depending on installation situation.

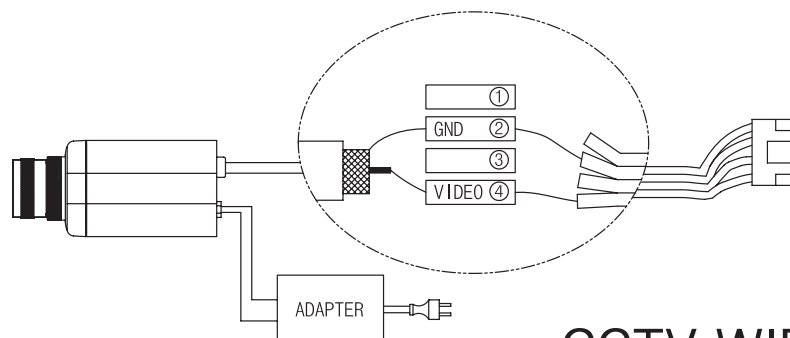

## CCTV WIRING



# 6. Installation Method

- Installation method of monitor

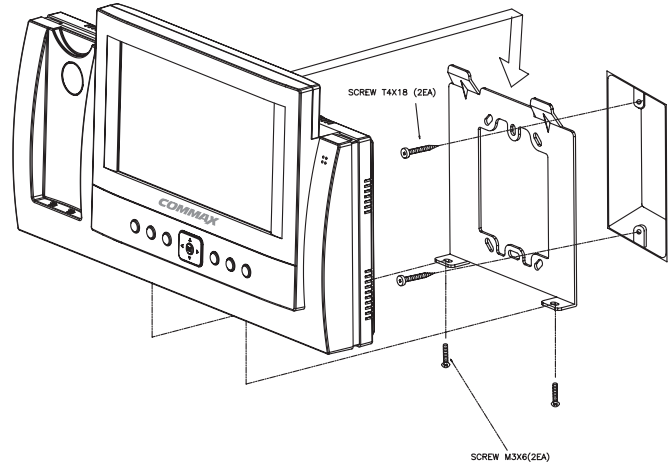
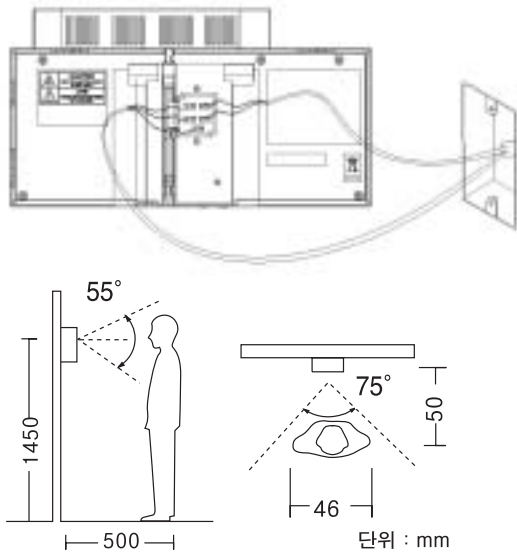

## ※ Notes for installing

- Please keep the product away from magnetism, severe moisture, direct sun rays and nearby heater, which may influence on the product
- Suitable height for main unit is 1450 ~ 1500mm from the bottom to the screen.
- Please arrange the handset after installation is completed
- Installation method of camera

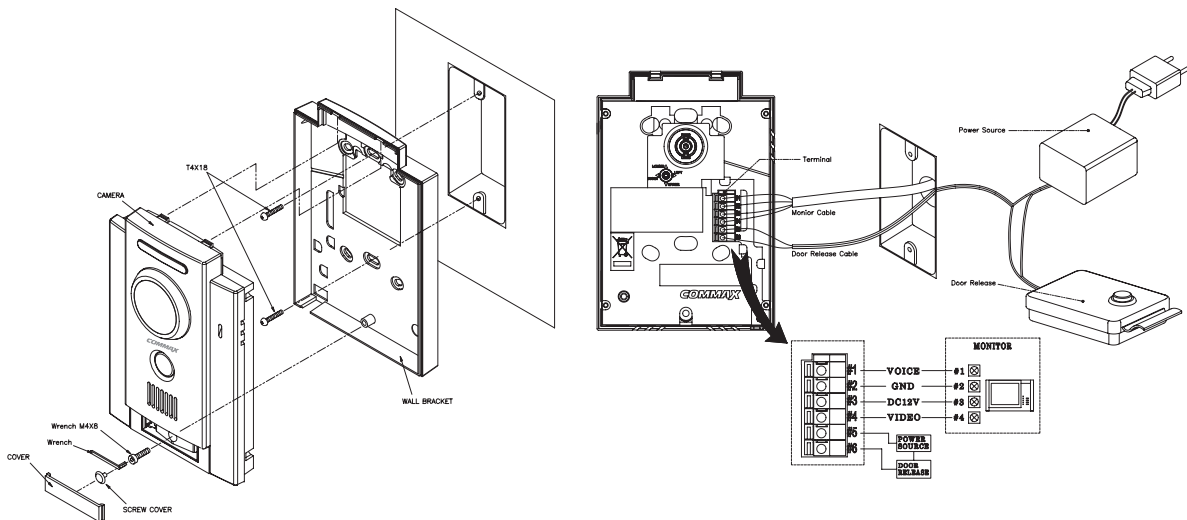

Please keep the product away from direct sun rays or strong reflected light.

You may not get clear screen quality.

# 7. Operating Description

## 1. Visitor Call & Monitoring

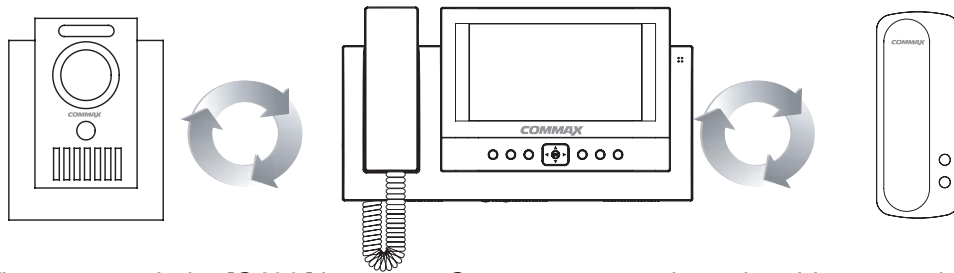

- When you push the [CALL] button on Camera, you can hear the chime sound from the monitor, sub-interphone, and Camera No. as well as visitor's picture will be shown on a screen.(Duration of on-screen : 30 sec)
- You can pick up the handset if you want to talk. If the screen is off while you're talking, you can push [MONITOR] button in order to speak again. (Duration of talking: 60 sec)
- After checking visitors, you can push [OPEN] button to open the door, while you press the button, the relay connection of door camera will be sustained.
- Press the [MONITOR] button to see condition of the door in standby state, and press the [RIGHT (▶)] or LEFT (◀) button to see the screen of next camera.
- While you are talking with door camera or you're monitoring, the door will be open if you press [OPEN] button.
- While talking or monitoring over the camera, you may store 1 cut, by pressing the REC/IMAGE button

## 2. Interphone(DP-4VR)

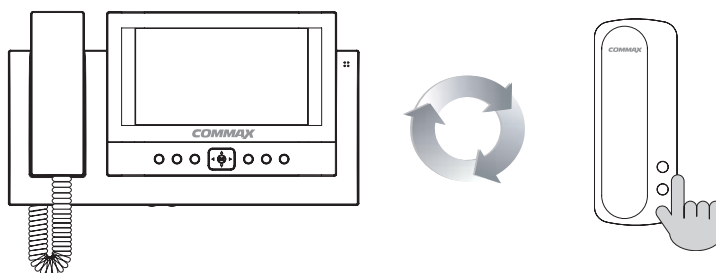

- When you pick up the handset and press the [INTERPHONE/ ●] button, you can hear the call sound from Sub interphone and Monitor. Then you can start talking
- In order to open the door from interphone, you can press door open [OPEN] button, and while you press the button, the relay connection of door camera will be sustained.

## 3. Picture Memory

### 3-1 Recording Manual

- While you are monitoring outside the house with CDV-71BE/71BD or talking through door phone, you can press the [REC./DEL.] button to save 1 cut of picture thru the door camera or CCTV camera.

### 3-2 Auto recording

- Record a visitor picture on the memory of CDV-71BE/71BD when you set the units on AWAY mode.
- Press [REC./DEL.] button before moving green box "ON" and then press [↵].



- The Green Lamp on the top of CDV-71BE/71BD will blink on the function of Auto Recording.

### 3-3 Erase a memory pictures.

- Press [REC./DEL.] button and then using [LEFT/RIGHT] button move to the green box to "YES" Then press [↵] button.



- To make sure that you are pressing the "YES" [↵] button with green box:

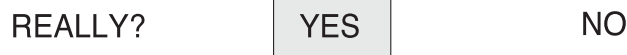

- ♠ Caution: Erase function erases ALL visitor's pictures.

## 4. Review function

- This function is to see the stored screens.
- Stored screens are shown per 6 screens and you can see 6 cuts in order with [REVIEW] button.

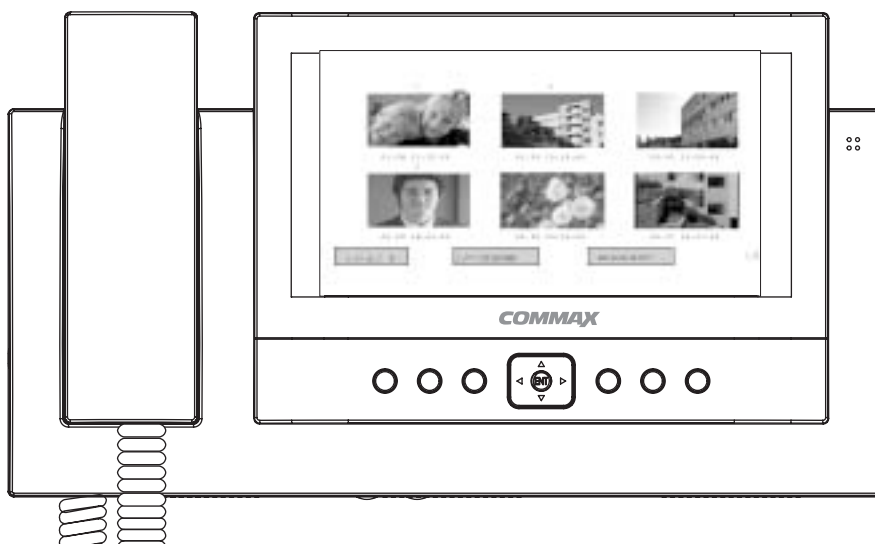

- You can select one of the 6 images of visitors picture recorded on screen using the [UP▲]/[DOWN▼] and [LEFT◀]/[RIGHT▶] buttons,
- Press [↵] button after moving the red bar to the image you want to enlarge.

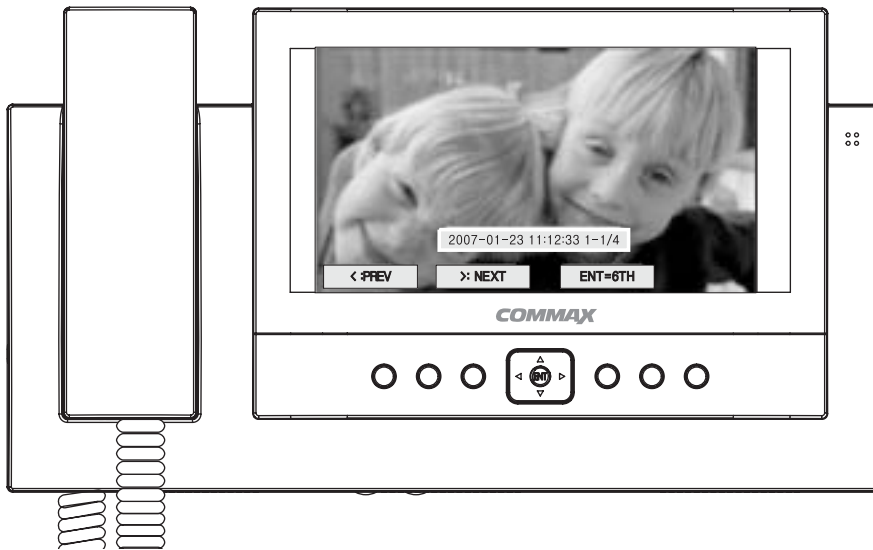

- Press [LEFT◀]/[RIGHT▶] button, you can see the pictures enlarged in order.
- Press [REVIEW] button to turn on stand by mode.
- An additional screen to be stored after completion of 128 cut stores, the screen is stored 1st image of 128 cut stores and 128th image will erase automatically in the memory

## 5. Time setting

- It is set to store the time when the screen is stored in the image memory
- Press [TIME] button then using [DOWN▼] button and [LEFT◀]/[RIGHT▶] button to change a number.

Year:	2007
Month:	01
Day:	28
Hour	11
Minute:	12

< >: UP DOWN      ENT : SET

- Press [↵] button to save time and turn to stand by.

## 6. Screen Adjustment

- This function enables screen adjustment by user.

The CONTROL MENU will be shown by pressing [↵] button for a long time while monitoring or talking with visitor.

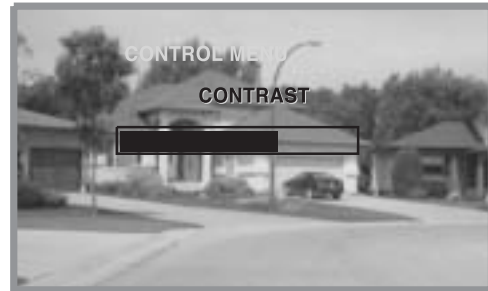
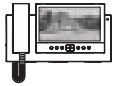

- If you press [RIGHT ▶] button, the control bar will be shown like the above picture after positioning [☞] mark at where you want to use the [UP ▲]/[DOWN ▼] buttons.
- You can level the value of each item up and down using [UP ▲]/[DOWN ▼] buttons. After finishing the setting, you can move to previous menu by pressing [RIGHT ▶] button.
- To initialize the screen adjustment, please press [RIGHT ▶] button in RESET place, then it is changed to the initialized value that is set on production.
- If all screen adjustment is completed, you can move to previous mode with pressing [↵] button.

## 7. Camera Setting

- It is connectable 4 cameras max
- In this menu, you can select the number of cameras that can be used, even connected or disconnected.
- The following picture will be shown with pressing [↵] button for over 3 seconds in stand-by status of screen off.

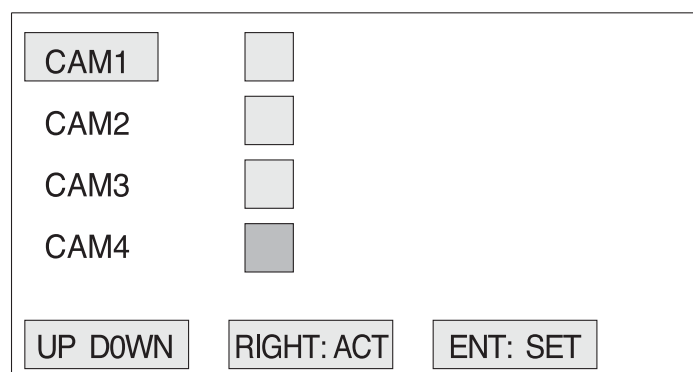

- You may change the activation of each camera pressing [RIGHT ◀] button where you want.
- Green box status stands for camera in use and Red box status stands for camera not in use.
- You can move to stand-by mode after finishing the setting
- The default value is set to use all 4 cameras after production.

## 8. Specification

ITEM	CDV-71BE
Wiring number	Camera : 4 lines in polarity, Sub interphone : 4 lines in polarity
Rated voltage	AC100-240V~, 50/60Hz
Power consumption (On operating)	25W (Max.)
Display unit	7" TFT-LCD
Call sound	Door(individual door):ring electronic chime 3 sounds twice repeatedly, Interphone :electronic melody sound
Image receiving time	30sec (On calling 60sec)
Memory	128cut
Communication distance	Door camera: 50M(at Ø0.65mm) / 70M(at Ø0.8mm) / 115M(atØ1.0mm)
	Sub interphone: 30M(at Ø0.65mm) / 50M(at Ø0.8mm)
Operating temperature	0°C~+40°C (32°F~104°F)
Dimension	315(W)x175(H)x53(D)
Weight	1.7Kg

ITEM	CDV-71BD
Wiring number	Camera : 4 lines in polarity, Sub interphone : 4 lines in polarity
Rated voltage	DC 17~30V / 1.5A
Power consumption (On operating)	1.3A (Max.)
Display unit	7" TFT-LCD
Call sound	Door(individual door):ring electronic chime 3 sounds twice repeatedly, Interphone :electronic melody sound
Image receiving time	30sec (On calling 60sec)
Memory	128cut
Communication distance	Door camera: 50M(at Ø0.65mm) / 70M(at Ø0.8mm) / 115M(atØ1.0mm)
	Sub interphone: 30M(at Ø0.65mm) / 50M(at Ø0.8mm)
Operating temperature	0°C~+40°C (32°F~104°F)
Dimension	315(W)x175(H)x53(D)
Weight	1.7Kg

memo .....

# **COMMAX**

**Blooming Life, HomeNetwork**

**COMMAX Co.,Ltd.**

a513-11, Sangdaewon-dong, Jungwon-gu, Seongnam-si, Gyeonggi-do, Korea

Int'l Business Dept. : Tel.; +82-31-7393-540~550 Fax.; +82-31-745-2133

Web site : [www.commax.com](http://www.commax.com)

*Printed In Korea/ 2007.05*