



Electric strikes for standard applications



ASSA ABLOY, the global leader
in door opening solutions



About us.

Whatever you want to secure,
protect, maintain - we have the
technology you require.

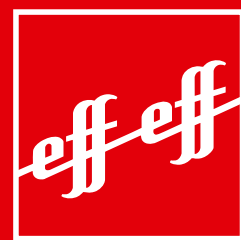

ASSA ABLOY



Arsenal Stadium, London

Breaking new grounds, implementing new technologies, developing new ideas. Founded in 1936, the company effeff based in Albstadt became the market leader in the field of door control systems by following a consistent strategy. After starting the electric strike production in 1947, a comprehensive product range has been gradually developed, which enables effeff to offer suitable solutions for every door.

February 1st, 2000, effeff joined the ASSA ALBOY Group based in Stockholm, Sweden and merged at the beginning of 2005 with IKON GmbH Präzisionstechnik, Berlin who also belong to the group to become ASSA ABLOY Sicherheitstechnik GmbH.



Court of Justice, Antwerpen

IKON and effeff, both renowned and well-established brands within the market remain under ASSA ABLOY Sicherheitstechnik GmbH as do the production sites of Berlin and Albstadt and the plant in Heiligenhaus.

ASSA ABLOY is the leading manufacturer and supplier of mechanical and electro-mechanical locks and related products worldwide. Our customers benefit from the extensive know-how of the largest international group of companies, meeting every requirement in terms of total security and comfort throughout the world.



Emirates Towers, Dubai



Airport Zurich

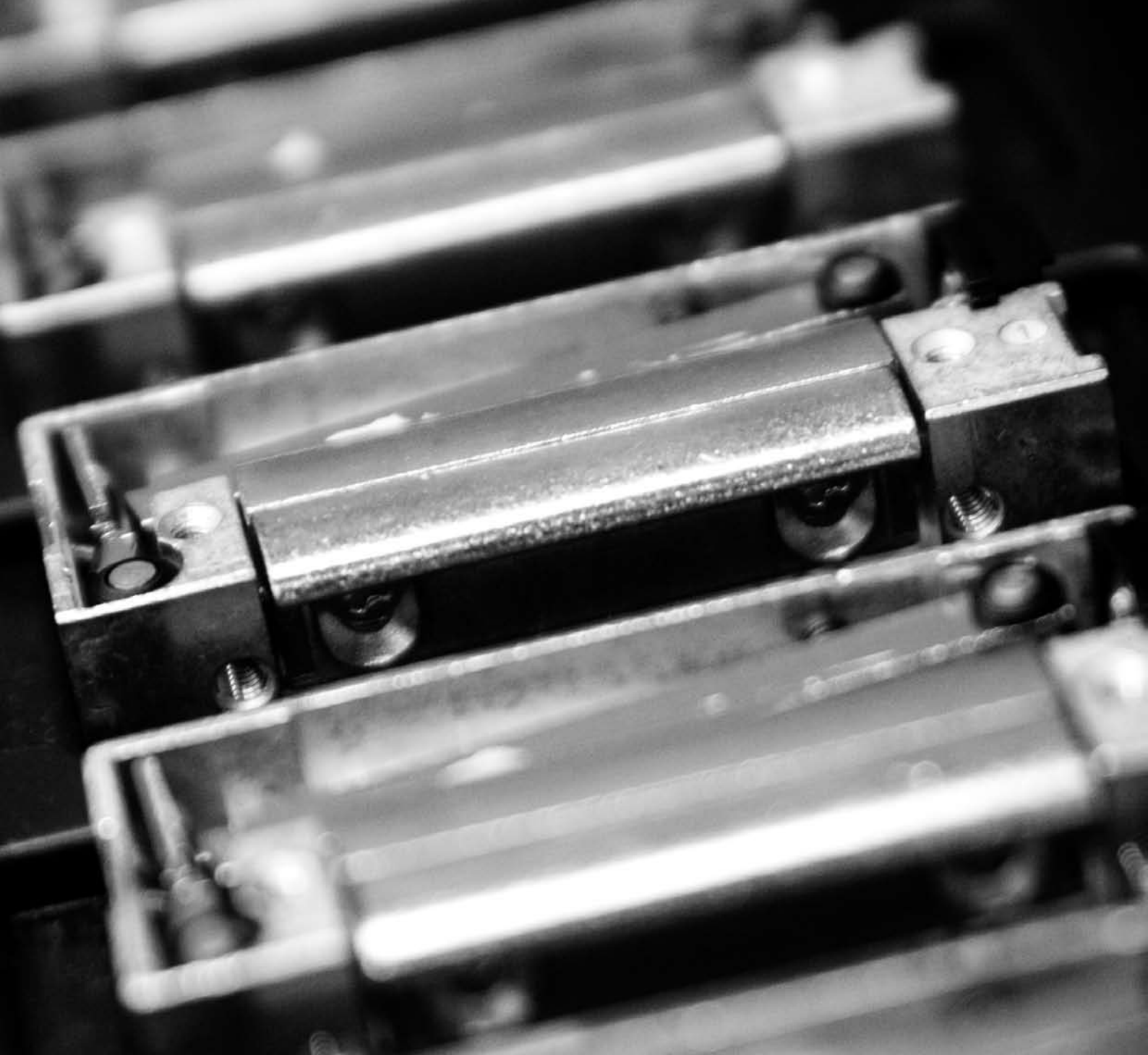

Standard electric strikes –
our products, our competence.



ASSA ABLOY

effeff door strikes offer a high degree of security and are easy to use. Our wide range fulfils all requirements and includes models for all types of installation. This applies worldwide as effeff products comply with both national and international regulations. effeff's convincing solutions for smoke protection doors, fire rated doors and doors in escape routes.

Table of Contents

About us	2 - 3
Table of contents	5
Technical information	6 - 9
Universal strike in a solid design	
Model series 14, 24 and 34	from page 10
Universal strike standard with FaFix (FF)	
Model series 17, 27 and 37	from page 24
Standard electric strike	
Model series 118, 128 and 138	from page 34
Standard-electric strike ProFix 2	
Model series 118, 128 and 138	from page 40
Universal electric strike with radius latch ProFix 1	
Model series 116, 126 and 136	from page 50
Water-resistant electric strikes	
Model series 12, 22 and 32	from page 60
Accessories	66 - 69
Dummy components	70 - 73
Surface-mounted attachments	
Model series 14, 24, 34 / 17, 27, 37 / 19, 29, 39	74
Model series 116, 126, 136	75
Model series 118	76
Technical explanations	
Abbreviations from A to Z	77
Determination of DIN Direction	78
The Fix and FaFix Function	79
The ProFix Principle: When ProFix 1, when ProFix 2?	80
Suffixes and their meaning	81
The electrical and technical details in the tables and their meaning	82 - 83
Order Form	84
Goods return form	85

Clearly arranged layout – comprehensive Information!

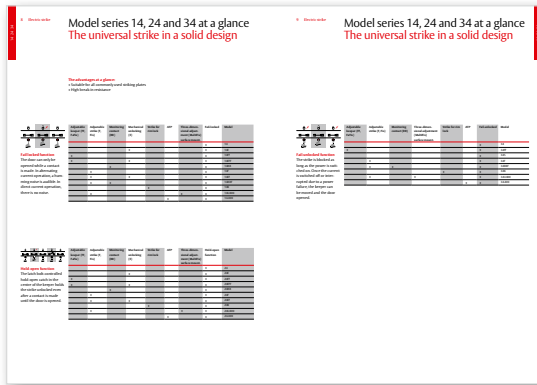

All models at a glance!

All relevant information at a glance – giving you the overview of the individual electric strike models.

On a double page you will find here all three series and their characteristics.

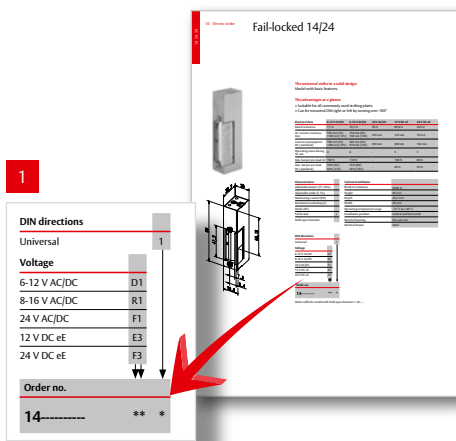

Comprehensive in its detail!

For every individual model we have gathered together and clearly arranged comprehensive technical data and summaries.

- 1 By transferring e.g. the voltage indication you will be able to simply add the order number to your desired electric strike model. So ordering is quite simple.

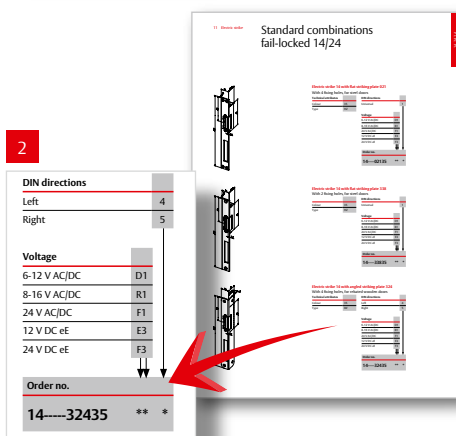

Electric strike and striking plate – the perfect combination!

We suggest a choice of matching striking plates for each electric strike. No complicated matching of order numbers: for every standard combination the right order number is listed with it.

- 2 Here too the voltage indication and DIN direction just have to be transferred and your individual electric strike is ready for use.

Is your combination not there? No Problem!

Further combinations are of course possible. Just have a word with us or look it up in our online Product Catalogue on www.effeff.com

The standard electric strikes – here each to its own.



When and where will the standard electric strike be used?

The standard electric strike is used everywhere where tumbler is to be combined with ease of use.

Typical areas of use are:

- Front doors in single occupancy houses
- Main entrance in multi-occupancy houses
- Property doors without relevant security function
- Entrance doors in office and business premises (e.g. doctor's, hairdresser's etc.)

The demands on the electric strike vary according to type of door. For the various options ASSA ABLOY Sicherheitstechnik offers the suitable electric strike:

- Wooden doors
- Metal doors
- Plastic doors
- Tubular frame profiles
- Solid leaf profiles

We assist you with words and deeds.

The experts at ASSA ABLOY Sicherheitstechnik would be pleased to advise you which electric strike model is most suitable for which installation position.

Hotline Technical advice

+49 7431 123-381

Hotline Sales/order processing

+49 7431 123-700

Support on the Internet

www.effeff.com

Technical advice

In the matter of technical advice, with us you will be supported by professionals who will continue to help you on every question on technical details. Of course you can also be put into contact with specialists for questions of detail in the matter of technical risk assessment or key accounts.

Sales advice/order processing

With our commercial customer services you can deal with all questions to do with your purchase order, for example the status of the order processing, the delivery date, purchase order changes, but also returns or guarantee issues. Use this simple and quick option to get information or help from our specialists. We will do that with pleasure.

Trade fairs

You will find effeff at many national and international trade fairs. You can obtain the exact dates from our website www.assaabloy.de

Our product catalogue online at www.effeff.com

**Fast and up-to-date
comprehensive product
information at any time**

The new online catalogue enables you to access the entire effeff product range quickly and easily. The user menu is optimally designed to quickly guide you through the effeff catalogue to the information you require.

The online catalogue and the effeff price list are laid out and designed in the same way as the printed versions, so that the customer can browse through easily as normal.

The comprehensive product summaries with practical search options provide detailed technical descriptions and product package info, along with dimensional drawings and images.

In addition to product descriptions, images and dimensions, each product page contains precise information on the supplied package, accessories and matching ASSA ABLOY products.

Information made easy

Use product images and product to directly access further information on the selected product; the user will easily find key information at a glance. All essential information on individual articles is available as a product specification sheet for download in PDF format.

We also provide you with downloads of prospectuses, brochures and catalogues in PDF format for individual products in their respective product range.

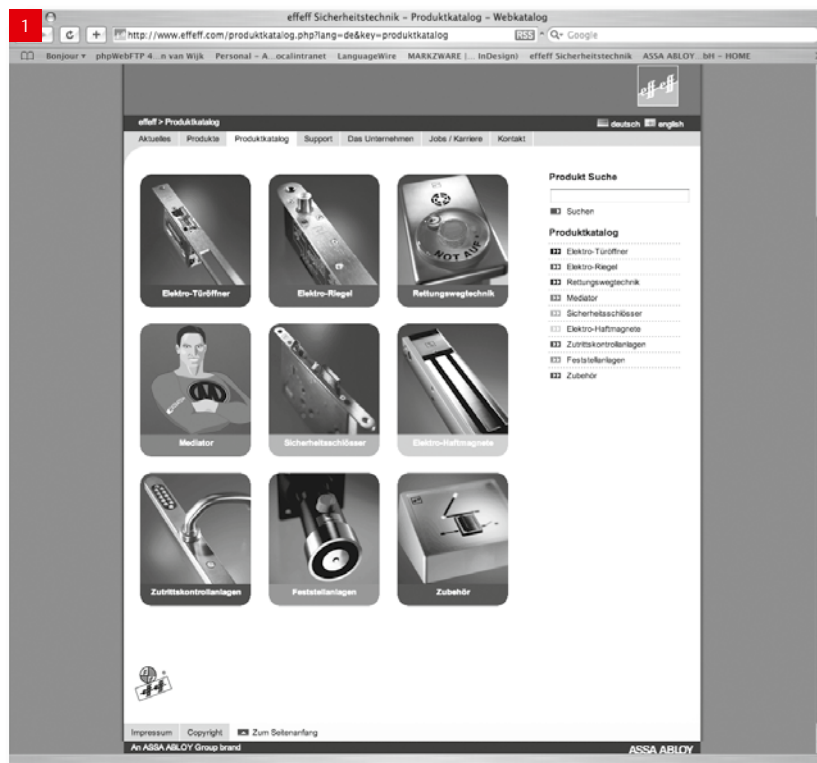

Our product catalogue online at www.effeff.com

1 Clearly arranged layout according to our different product areas...

2 the submenu will help you navigate through our database...

3 to find the model you need.

4 By just clicking on the article, you can generate a detailed specification sheet.

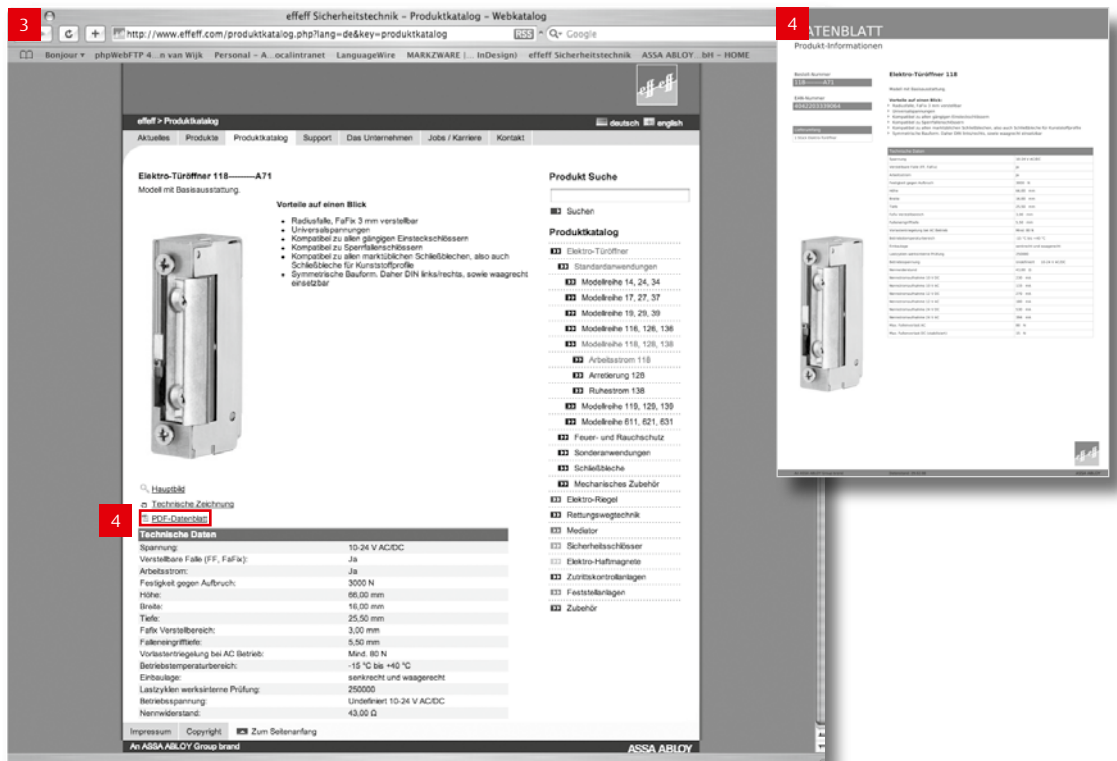

Model series 14, 24 and 34 at a glance

The universal strike in a solid design

The advantages at a glance:

- Suitable for all commonly used striking plates
- High break-in resistance

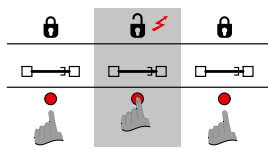

Fail locked function

The door can only be opened while a contact is made. In alternating current operation, a humming noise is audible. In direct current operation, there is no noise.

Adjustable keeper (FF, FaFix)	Adjustable strike (F, Fix)	Monitoring contact (RR)	Mechanical unlocking (E)	Strike for rim lock	ATP	Three-dimensional adjustment (MultiFix) surface mount.	Fail-locked	Model
							•	14
			•				•	14E
•			•				•	14FF
•			•				•	14EFF
		•					•	14RR
	•						•	14F
	•		•				•	14EF
	•	•					•	14RRF
				•			•	14K
	•					•	•	14U400
					•		•	14.400

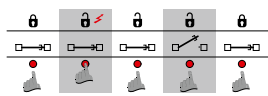

Hold-open function

The latch bolt-controlled hold-open catch in the centre of the keeper holds the strike unlocked even after a contact is made until the door is opened.

Adjustable keeper (FF, FaFix)	Adjustable strike (F, Fix)	Monitoring contact (RR)	Mechanical unlocking (E)	Strike for rim lock	ATP	Three-dimensional adjustment (MultiFix) surface mount.	Hold-open function	Model
							•	24
			•				•	24E
•			•				•	24FF
•			•				•	24EFF
		•					•	24RR
	•						•	24F
	•		•				•	24EF
				•			•	24K
	•					•	•	24U400
					•		•	24.400

Model series 14, 24 and 34 at a glance

The universal strike in a solid design

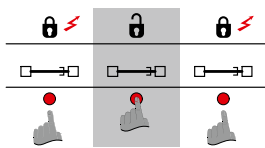

Fail-unlocked function

The strike is blocked as long as the power is switched on. Once the current is switched off or interrupted due to a power failure, the keeper can be moved and the door opened.

Adjustable keeper (FF, FaFix)	Adjustable strike (F, Fix)	Monitoring contact (RR)	Three-dimensional adjustment (MultiFix) surface mount.	Strike for rim lock	ATP	Fail-unlocked	Model
						•	34
•						•	34FF
						•	34S
	•					•	34F
	•	•				•	34RRF
				•		•	34K
	•		•			•	34U400
					•	•	34.400

Fail-locked 14/24

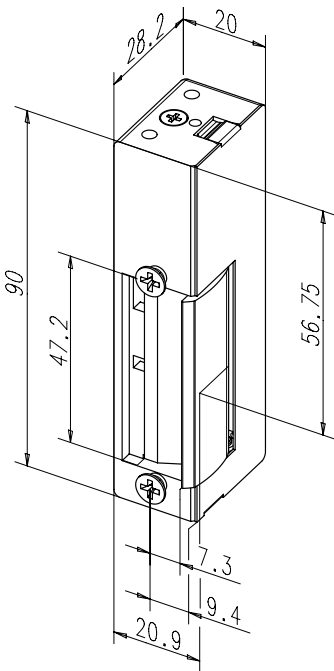

The universal strike in a solid design

Model with basic features.

The advantages at a glance

- Suitable for all commonly used striking plates
- Can be mounted DIN right or left by turning over 180°

Electrical data	6-12 V AC/DC	8-16 V AC/DC	24 V AC/DC	12 V DC eE	24 V DC eE
Rated resistance	7,7 Ω	16,5 Ω	59 Ω	60,0 Ω	235 Ω
AC current consumption	550 mA (6V) 1100 mA (12V)	350 mA (8V) 700 mA (16V)	370 mA	125 mA	70 mA
Current consumption DC (stabilised)	780 mA (6V) 1560 mA (12V)	485 mA (8V) 970 mA (16V)	410 mA	200 mA	102 mA
Operating noise during AC use	4	4	-	3	3
Max. keeper pre-load AC	160 N	110 N	-	100 N	80 N
Max. keeper pre-load DC (stabilised)	10 N (6V) 60 N (12V)	10 N (8V) 20 N (16V)	-	40 N	25 N

Characteristics

Adjustable keeper (FF, FaFix)	
Adjustable strike (F, Fix)	
Monitoring contact (RR)	
Mechanical unlocking (E)	
Diode (05)	
Fail-locked	•
Hold-open function	

Technical attributes

Break-in resistance	6500 N
Height	90 mm
Depth	28,2 mm
Width	20 mm
Operating temperature range	-15 °C to +40 °C
Installation position	vertical and horizontal
Material housing	Die-cast zinc
Material keeper	Steel

DIN directions

Universal	1
-----------	---

Voltage

6-12 V AC/DC	D1
8-16 V AC/DC	R1
24 V AC/DC	F1
12 V DC eE	E3
24 V DC eE	F3

Order no.

14----- ** *

Order suffix for model with hold open function = 24 -...

Standard combinations fail-locked 14/24

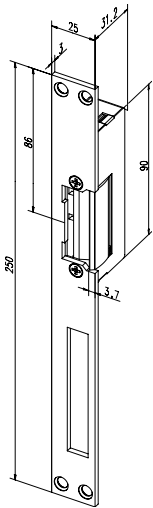

Electric strike 14 with flat striking plate 021

With 4 fixing holes, for steel doors

Technical attributes		DIN directions	
Colour	35	Universal	1
Type	HZ		
		Voltage	
		6-12 V AC/DC	D1
		8-16 V AC/DC	R1
		24 V AC/DC	F1
		12 V DC eE	E3
		24 V DC eE	F3
		Order no.	
		14-----02135	** *

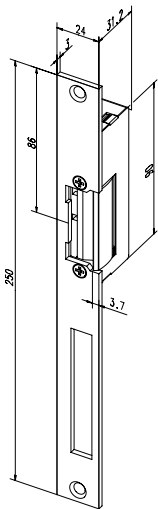

Electric strike 14 with flat striking plate 338

With 2 fixing holes, for steel doors

Technical attributes		DIN directions	
Colour	35	Universal	1
Type	HZ		
		Voltage	
		6-12 V AC/DC	D1
		8-16 V AC/DC	R1
		24 V AC/DC	F1
		12 V DC eE	E3
		24 V DC eE	F3
		Order no.	
		14-----33835	** *

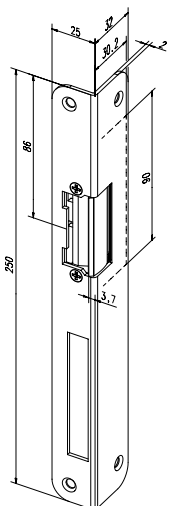

Electric strike 14 with angled striking plate 324

With 4 fixing holes, for rebated wooden doors

Technical attributes		DIN directions	
Colour	35	Left	4
Type	iW	Right	5
		Voltage	
		6-12 V AC/DC	D1
		8-16 V AC/DC	R1
		24 V AC/DC	F1
		12 V DC eE	E3
		24 V DC eE	F3
		Order no.	
		14-----32435	** *

Standard combinations fail-locked 14/24

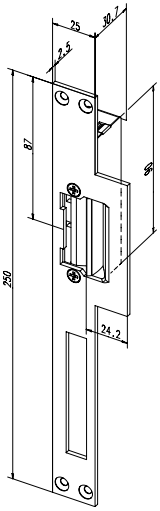

Electric strike 14 with flanged striking plate 165

With 4 fixing holes, for flush wooden doors

Colour	35	DIN directions	
Type	Lap	Left	4
		Right	5
		Voltage	
		6-12 V AC/DC	D1
		8-16 V AC/DC	R1
		24 V AC/DC	F1
		12 V DC eE	E3
		24 V DC eE	F3
		12 V Intercom	E5
		Order no.	
		14LAP--16535	** *

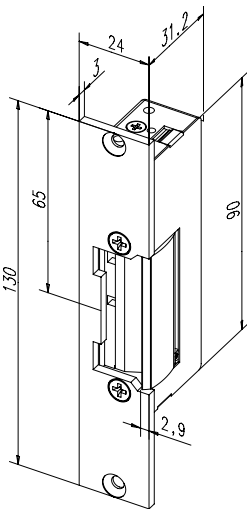

Electric strike 14 with short flat striking plate 096

With 2 fixing holes, for steel doors without dead bolt

Technical attributes		DIN directions	
Colour	35	Universal	1
Type	kl		
		Voltage	
		6-12 V AC/DC	D1
		8-16 V AC/DC	R1
		24 V AC/DC	F1
		12 V DC eE	E3
		24 V DC eE	F3
		Order no.	
		14-----09635	** *

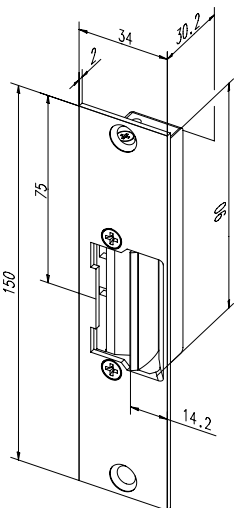

Electric strike 14 with short flat striking plate 262

With 2 fixing holes, for flush wooden doors without dead bolt

		DIN directions	
Colour	35	Universal	1
Type	kF		
		Voltage	
		6-12 V AC/DC	D1
		8-16 V AC/DC	R1
		24 V AC/DC	F1
		12 V DC eE	E3
		24 V DC eE	F3
		12 V Intercom	E5
		Order no.	
		14KF---26235	** *

Standard combinations fail-locked 14K

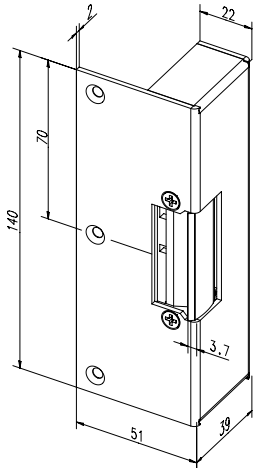

Electric strike 14K with housing 198

For rim mounting

Technical attributes	
Colour	02
Type	KiS

DIN directions	
Universal	1

Voltage	
6-12 V AC/DC	D1
8-16 V AC/DC	R1
24 V AC/DC	F1
12 V DC eE	E3
24 V DC eE	F3

Order no.		
14K----	19802	** *

Fail-locked 14U400

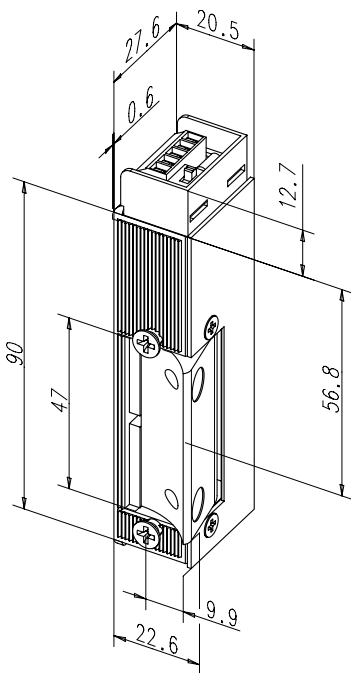

Strike for special applications panic door lock with horizontal push bar

The MultiFix rim-type strike combines design and functionality in one unique, patented unit. The surface-mounted housing can be combined with existing effeff ATP door strikes renowned for their reliability.

The advantages at a glance

- Vertical and horizontal mounting possible
- Can be mounted DIN right or left by turning over 180°
- Three-dimensional adjustment
- 12/24 V changeover switch and suppressor diode

Electrical data	12/24 V DC eE
Rated resistance	57,5 Ω
AC current consumption	130 mA
Current consumption DC (stabilised)	210 mA
Operating noise during AC use	3
Max. keeper pre-load AC	50 N
Max. keeper pre-load DC (stabilised)	10 N

Characteristics	Technical attributes
Adjustable keeper (FF, FaFix)	Break-in resistance 3000 N
Adjustable strike (F, Fix)	Height 102,7 mm
Monitoring contact (RR)	Width 20,5 mm
Mechanical unlocking (E)	Depth 27,6 mm
Diode (05)	Operating temperature range -15 °C to +40 °C
Fail-locked	Installation position vertical and horizontal
Hold-open function	Material housing Die-cast zinc
Three-dimensional adjustment (MultiFix)	Material keeper Brass

DIN directions	
Universal	1
Voltage	
12/24 V DC eE	Q3
Order no.	
14U400-----	** *

Standard combinations fail-locked 14U400

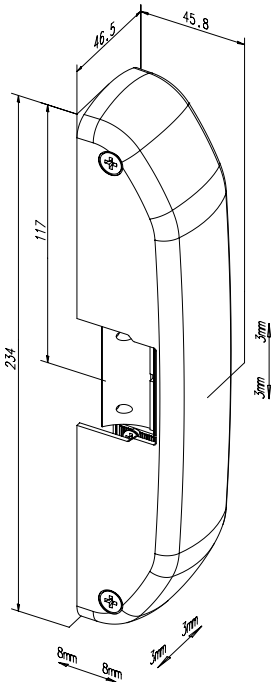

Electric strike 14U400 with housing A06

Technical attributes	
Colour	05
Type	A06

DIN directions	
Universal	1

Voltage	
12/24 V DC eE	Q3

Order no.	
14U400-A0605	** *

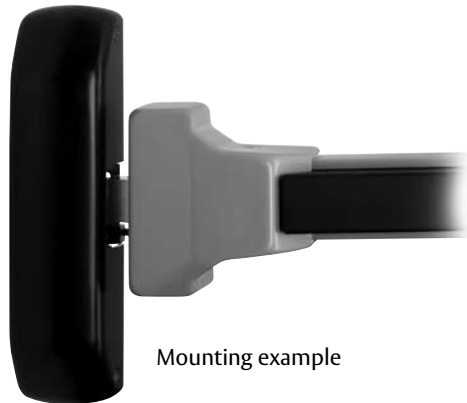

Dimensions

The three-dimensional adjustability simplifies installation considerably and offers the option of subsequent adjustments thus covering all popular applications with minimal effort and without the necessity for alternative cover versions or spacers.

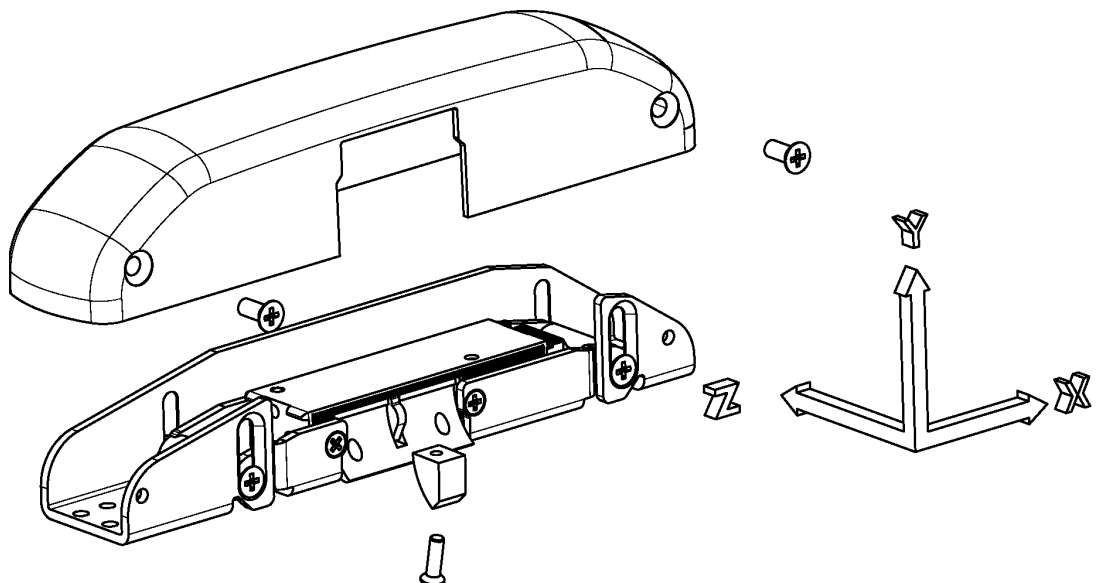

Fail-locked 14.400

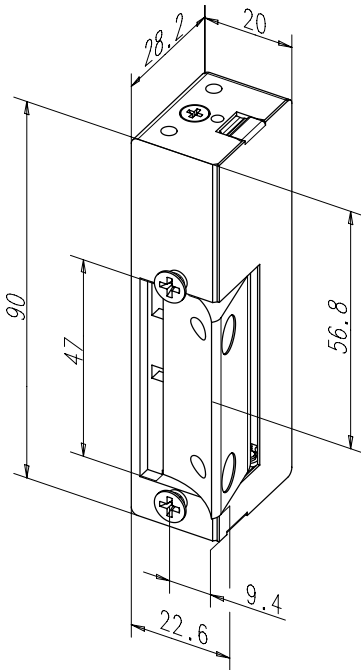

Electric strikes for special applications

Electric strike for surface-mounted panic door locks with horizontal actuating bar.

The advantages at a glance

- Can be mounted DIN right or left by turning over 180°

Electrical data	6-12 V AC/DC	8-16 V AC/DC	24 V AC/DC	12 V DC eE	24 V DC eE
Rated resistance	7,7 Ω	16,5 Ω	59 Ω	60,0 Ω	235 Ω
AC current consumption	550 mA (6V) 1100 mA (12V)	350 mA (8V) 700 mA (16V)	370 mA	125 mA	70 mA
Current consumption DC (stabilised)	780 mA (6V) 1560 mA (12V)	485 mA (8V) 970 mA (16V)	410 mA	200 mA	102 mA
Operating noise during AC use	4	4	-	3	3

Characteristics	Technical attributes
Adjustable keeper (FF, FaFix)	Break-in resistance 3000 N
Adjustable strike (F, Fix)	Height 90 mm
Monitoring contact (RR)	Width 20 mm
Mechanical unlocking (E)	Depth 28,2 mm
Diode (05)	Operating temperature range -15 °C to +40 °C
Fail-locked •	Installation position vertical and horizontal
Hold-open function	Material housing Powder-coated die-cast zinc
ATP •	Material keeper Coated brass

DIN directions
Universal 1
Voltage
6-12 V AC/DC D1
8-16 V AC/DC R1
24 V AC/DC F1
12 V DC eE E3
24 V DC eE F3
Order no.
14.400 ----- ** *

Standard combinations fail-locked 14.400

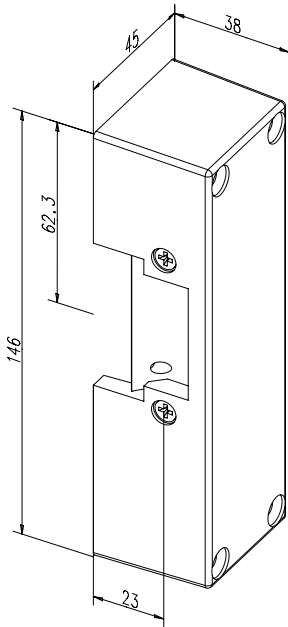

Electric strike 14.400 with housing 201

Technical attributes

Colour	05
Type	ATP

DIN directions

Universal	1
-----------	---

Voltage

6-12 V AC/DC	D1
8-16 V AC/DC	R1
24 V AC/DC	F1
12 V DC eE	E3
24 V DC eE	F3

Order no.

14.400-20105	**	*
--------------	----	---

Fail-unlocked 34

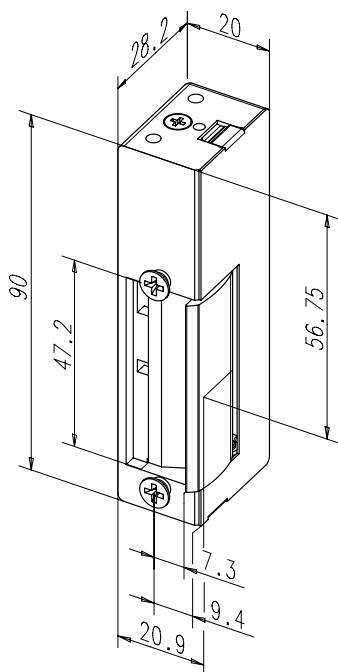

The universal strike in a solid design

Model with basic features.

The advantages at a glance

- Can be mounted DIN right or left by turning over 180°

Electrical data	12 V DC	24 V DC
Rated resistance	61 Ω	230 Ω
Current consumption DC (stabilised)	195 mA	105 mA
Max. keeper pre-load DC (stabilised)	10 N	10 N

Characteristics	Technical attributes	
Adjustable keeper (FF, FaFix)	Break-in resistance	6500 N
Adjustable strike (F, Fix)	Height	90 mm
Monitoring contact (RR)	Width	20 mm
Diode (05)	Depth	28,2 mm
Fail-unlocked	Operating temperature range	-15 °C to +40 °C
Hold-open function	Installation position	vertical and horizontal
	Material housing	Die-cast zinc
	Material keeper	Steel

DIN directions	
Universal	1
Voltage	
12 V DC	E9
24 V DC	F9
Order no.	
34-----	** *

Standard combinations fail-unlocked 34

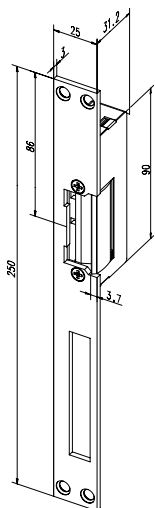

Electric strike 34 with flat striking plate 021

With 4 fixing holes, for steel doors

Technical attributes		DIN directions	
Colour	35	Universal	1
Type	HZ		
		Voltage	
		12 V DC	E9
		24 V DC	F9
		Order no.	
		34-----02135	** *

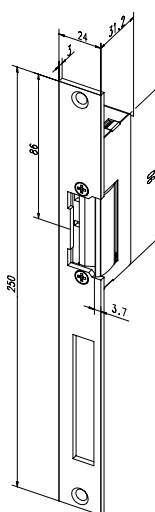

Electric strike 34 with flat striking plate 338

With 2 fixing holes, for steel doors

Technical attributes		DIN directions	
Colour	35	Universal	1
Type	HZ		
		Voltage	
		12 V DC	E9
		24 V DC	F9
		Order no.	
		34-----33835	** *

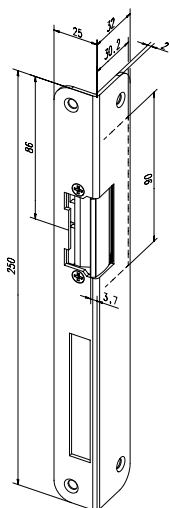

Electric strike 34 with angled striking plate 324

With 4 fixing holes, for rebated wooden doors

Technical attributes		DIN directions	
Colour	35	Left	4
Type	iW	Right	5
		Voltage	
		12 V DC	E9
		24 V DC	F9
		Order no.	
		34-----32435	** *

Standard combinations fail-unlocked 34

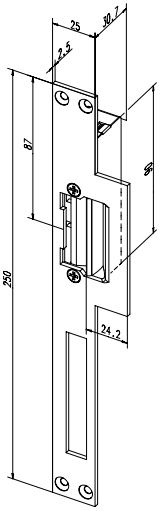

Electric strike 34 with flanged striking plate 165

With 4 fixing holes, for flush wooden doors

Technical attributes	
Colour	35
Type	Lap

DIN directions	
Left	4
Right	5

Voltage	
12 V DC	E9
24 V DC	F9

Order no.		
34LAP--16535	**	*

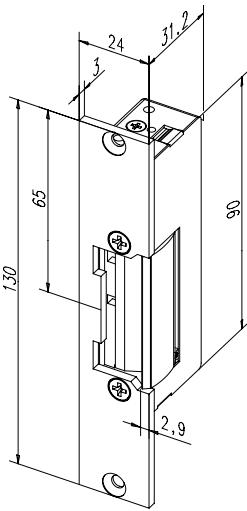

Electric strike 34 with short flat striking plate 096

With 2 fixing holes, for steel doors without dead bolt

Technical attributes	
Colour	35
Type	kl

DIN directions	
Universal	1

Voltage	
12 V DC	E9
24 V DC	F9

Order no.		
34----09635	**	*

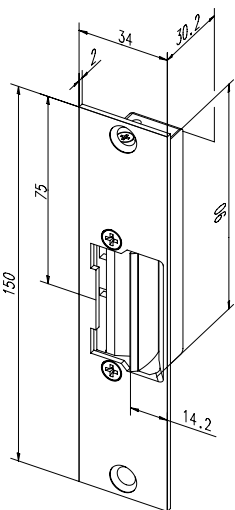

Electric strike 34 with short flat striking plate 262

With 2 fixing holes, for flush wooden doors without dead bolt

Technical attributes	
Colour	35
Type	kF

DIN directions	
Universal	1

Voltage	
12 V DC	E9
24 V DC	F9

Order no.		
34KF---26235	**	*

Standard combinations fail-unlocked 34K

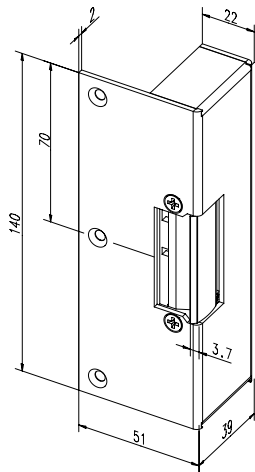

Electric strike 34K with housing 198

For rim mounting

Technical attributes	
Colour	02
Type	KiS

DIN directions	
Universal	1
Voltage	
12 V DC	E9
24 V DC	F9
Order no.	
34K----	19802 ** *

Model series 17, 27 and 37 at a glance

Universal strike standard with FaFix (FF)

17 27 37

The advantages at a glance:

- Suitable for all commonly used striking plates
- Can be mounted DIN right or left by turning over 180°
- Symmetrical design

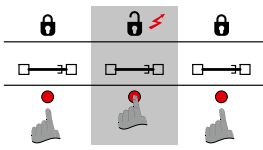

Fail locked function

The door can only be opened while a contact is made. In alternating current operation, a humming noise is audible. In direct current operation, there is no noise.

Adjustable keeper (FF, FaFix)	Monitoring contact (RR)	Mechanical unlocking (E)	Diode (05)	Fail-locked	Model
•				•	17
•		•		•	17E
•	•			•	17RR
•	•	•		•	17RRE
•			•	•	1705
•	•		•	•	1705RR

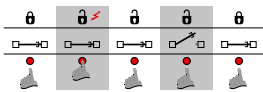

Hold-open function

The latch bolt-controlled hold-open catch in the centre of the keeper holds the strike unlocked even after a contact is made until the door is opened.

Adjustable keeper (FF, FaFix)	Mechanical unlocking (E)	Hold-open function	Model
•		•	27
•	•	•	27E
•		•	2705
•	•	•	2705E

Model series 17, 27 and 37 at a glance

Universal strike standard with FaFix (FF)

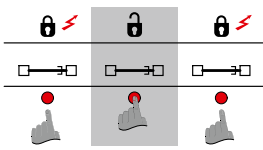

Fail-unlocked function

The strike is blocked as long as the power is switched on. Once the current is switched off or interrupted due to a power failure, the keeper can be moved and the door opened.

Adjustable keeper (FF, FaFix)	Monitoring contact (RR)	Diode (05)	Fail-unlocked	Model
•			•	37
•	•		•	37RR
•		•	•	3705
•	•	•	•	3705RR

Fail-locked 17/27

17 27 37

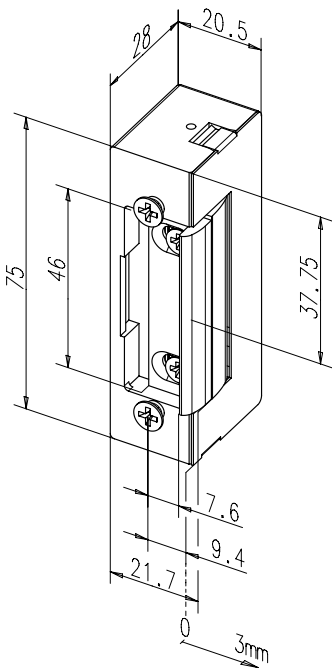

Universal strike standard with FaFix (FF)

Model with basic features.

The advantages at a glance

- Suitable for all commonly used striking plates
- Can be mounted DIN right or left by turning over 180°
- Symmetrical design

Electrical data	6-12 V AC/DC	8-16 V AC/DC	24 V AC/DC	12 V 100% ED	24 V 100% ED
Rated resistance	9,1 Ω	22 Ω	43 Ω	44 Ω	200 Ω
AC current consumption	550 mA (6V) 1100 mA (12V)	310 mA (8V) 470 mA (12V) 620 mA (16V)	400 mA	-	-
Current consumption DC (stabilised)	660 mA (6V) 1300 mA (12V)	360 mA (8V) 550 mA (12V) 730 mA (16V)	550 mA	270 mA	120 mA
Operating noise during AC use	5	4 (8V) 5 (12V) 5 (16V)	-	-	-
Max. keeper pre-load AC	80 N (6V) 150 N (12V)	60 N (8V) 150 N (12V) 150 N (16V)	-	-	-
Max. keeper pre-load DC (stabilised)	10 N (6V) 50 N (12V)	10 N	-	10 N	10 N

Characteristics

- Adjustable keeper (FF, FaFix)
- Adjustable strike (F, Fix)
- Monitoring contact (RR)
- Mechanical unlocking (E)
- Diode (05)
- Fail-locked
- Hold-open function

Technical attributes

Break-in resistance	3500 N
Height	75 mm
Width	20,5 mm
Depth	28 mm
Operating temperature range	-15 °C to +40 °C
Installation position	vertical and horizontal
Material housing	Die-cast zinc
Material keeper	Die-cast zinc
Material surface-mounted attachment	Die-cast zinc

DIN directions

Universal 1

Voltage

6-12 V AC/DC	D1
8-16 V AC/DC	R1
24 V AC/DC	F1
12 V 100% ED	E4
24 V 100% ED	F4

Order no.

17----- ** *

Order suffix for model with hold open function = 27 -...

Standard combinations fail-locked 17/27

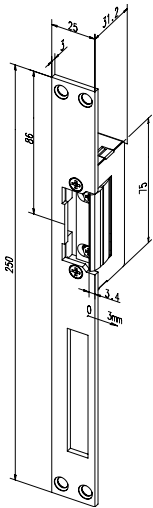

Electric strike 17 with flat striking plate 021

With 4 fixing holes, for steel doors

Technical attributes	
Colour	35
Type	HZ

DIN directions	
Universal	1

Voltage	
6-12 V AC/DC	D1
8-16 V AC/DC	R1
24 V AC/DC	F1
12 V 100% ED	E4
24 V 100% ED	F4

Order no.		
17-----02135	**	*

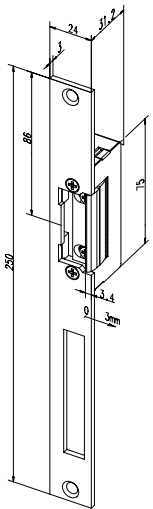

Electric strike 17 with flat striking plate 338

With 2 fixing holes, for steel doors

Technical attributes	
Colour	35
Type	HZ

DIN directions	
Universal	1

Voltage	
6-12 V AC/DC	D1
8-16 V AC/DC	R1
24 V AC/DC	F1
12 V 100% ED	E4
24 V 100% ED	F4

Order no.		
17-----33835	**	*

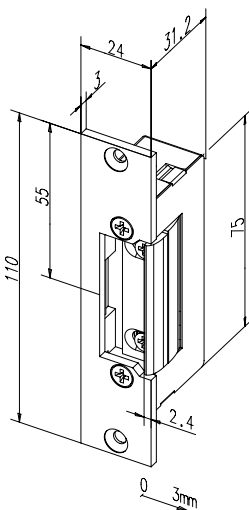

Electric strike 17 with short flat striking plate 106

With 2 fixing holes, for steel doors

Technical attributes	
Colour	35
Type	kl

DIN directions	
Universal	1

Voltage	
6-12 V AC/DC	D1
8-16 V AC/DC	R1
24 V AC/DC	F1
12 V 100% ED	E4
24 V 100% ED	F4

Order no.		
17-----10635	**	*

Standard combinations fail-locked 17/27

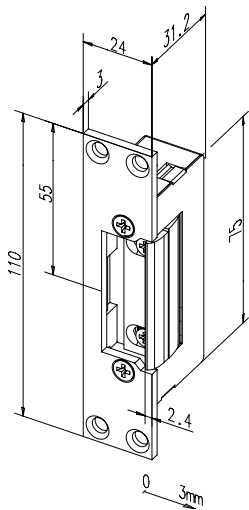

Electric strike 17 with short flat striking plate 107

With 4 fixing holes, for steel doors

Technical attributes	
Colour	02
Type	kl

DIN directions	
Universal	1

Voltage	
6-12 V AC/DC	D1
8-16 V AC/DC	R1
24 V AC/DC	F1
12 V 100% ED	E4
24 V 100% ED	F4

Order no.	
17-----10702	** *

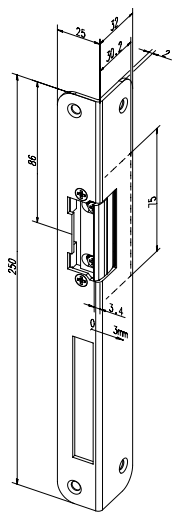

Electric strike 17 with angled striking plate 324

With 4 fixing holes, for rebated wooden doors

Technical attributes	
Colour	35
Type	iW

DIN directions	
Left	4
Right	5

Voltage	
6-12 V AC/DC	D1
8-16 V AC/DC	R1
24 V AC/DC	F1
12 V 100% ED	E4
24 V 100% ED	F4

Order no.	
17-----32435	** *

Standard combinations fail-locked 17/27

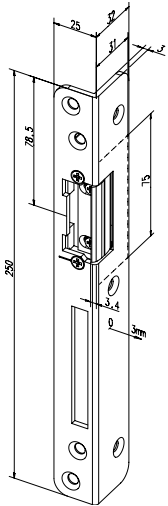

Electric strike 17 with angled striking plate 069

With 6 fixing holes, for rebated wooden doors, 3 mm thickness

Technical attributes

Colour	35
Type	iW3

DIN directions

Left	4
Right	5

Voltage

6-12 V AC/DC	D1
8-16 V AC/DC	R1
24 V AC/DC	F1
12 V 100% ED	E4
24 V 100% ED	F4

Order no.

17-----06935	**	*
--------------	----	---

Fail-unlocked 37

17 27 37

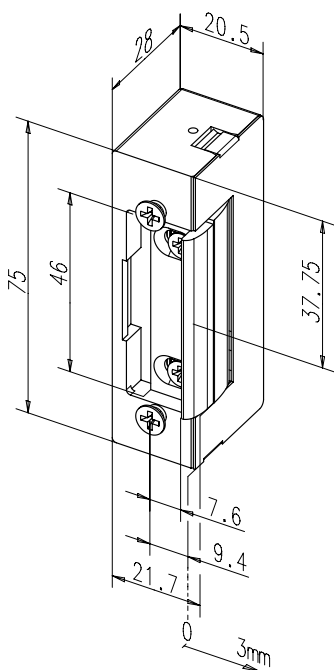

Universal strike standard with FaFix (FF)

Model with basic features.

The advantages at a glance

- Suitable for all commonly used striking plates
- Can be mounted DIN right or left by turning over 180°
- Symmetrical design

Electrical data	12 V DC	24 V DC
Rated resistance	44 Ω	200 Ω
Current consumption DC (stabilised)	270 mA	120 mA
Max. keeper pre-load DC (stabilised)	10 N	10 N

Characteristics	Technical attributes
Adjustable keeper (FF, FaFix)	Break-in resistance 3500 N
Adjustable strike (F, Fix)	Height 75 mm
Monitoring contact (RR)	Width 20,5 mm
Diode (05)	Depth 28 mm
Fail-unlocked	Operating temperature range -15 °C to +40 °C
Hold-open function	Installation position vertical and horizontal
	Material housing Die-cast zinc
	Material keeper Die-cast zinc
	Material surface-mounted attachment Die-cast zinc

DIN directions	
Universal	1
Voltage	
12 V DC	E9
24 V DC	F9
Order no.	
37-----	** *

Standard combinations fail-unlocked 37

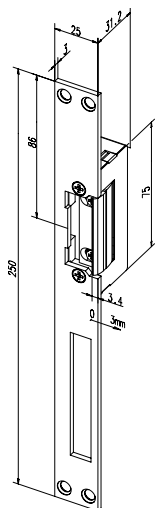

Electric strike 37 with flat striking plate 021

With 4 fixing holes, for steel doors

Technical attributes	
Colour	35
Type	HZ

DIN directions	
Universal	1

Voltage	
12 V DC	E9
24 V DC	F9

Order no.		
37-----02135	**	*

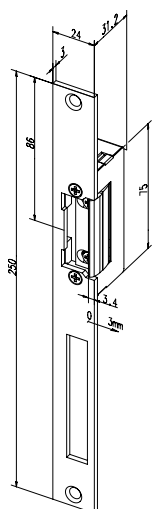

Electric strike 37 with flat striking plate 338

With 2 fixing holes, for steel doors

Technical attributes	
Colour	35
Type	HZ

DIN directions	
Universal	1

Voltage	
12 V DC	E9
24 V DC	F9

Order no.		
37-----33835	**	*

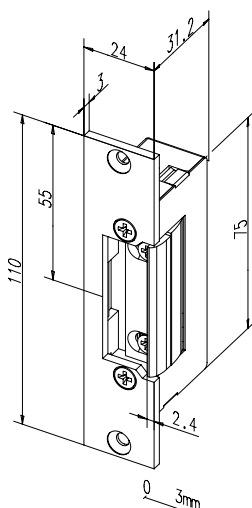

Electric strike 37 with short flat striking plate 106

With 2 fixing holes, for steel doors

Technical attributes	
Colour	35
Type	kl

DIN directions	
Universal	1

Voltage	
12 V DC	E9
24 V DC	F9

Order no.		
37-----10635	**	*

Standard combinations fail-unlocked 37

17 27 37

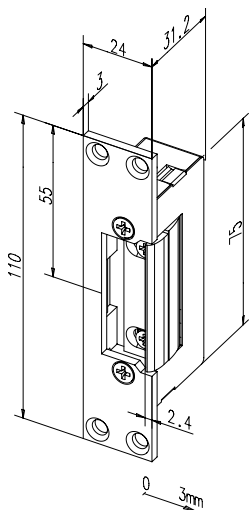

Electric strike 37 with short flat striking plate 107

With 4 fixing holes, for steel doors

Technical attributes	
Colour	02
Type	kl

DIN directions	
Universal	1
Voltage	
12 V DC	E9
24 V DC	F9
Order no.	
37-----10702	** *

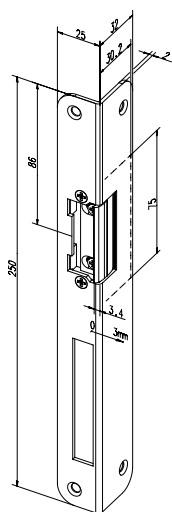

Electric strike 37 with angled striking plate 324

With 4 fixing holes, for rebated wooden doors

Technical attributes	
Colour	35
Type	iW

DIN directions	
Left	4
Right	5
Voltage	
12 V DC	E9
24 V DC	F9
Order no.	
37-----32435	** *

Standard combinations fail-unlocked 37

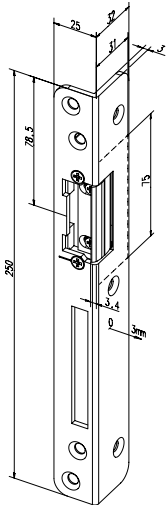

Electric strike 37 with angled striking plate 069

With 6 fixing holes, for rebated wooden doors, 3 mm thickness

Technical attributes		DIN directions	
Colour	35	Left	4
Type	iW3	Right	5
		Voltage	
		12 V DC	E9
		24 V DC	F9
		<div style="display: flex; justify-content: space-around; align-items: center;"> <div style="text-align: center;"> ↓ ↓ </div> </div>	
Order no.			
37-----06935		**	*

Model series 118, 128 and 138 at a glance

Standard electric strike 118, minimum fitting size - maximum effect

effeff standard electric strike 118

With the minimal size of 66 mm x 25,5 mm the electric strike 118 from effeff is the world wide smallest standard strike.

The advantages at a glance:

- Radius keeper, FaFix 3 mm adjustable
- Universal voltage
- Pluggable connecting cable available
- Compatible with all current mortise locks
- Compatible with all commercially available striking plates also striking plates for plastic profiles
- Extended time test 250.000 cycles
- Symmetrical design. DIN left/right as well as horizontal applicable

118 128 138

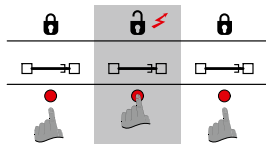

Fail locked function

The door can only be opened while a contact is made. In alternating current operation, a humming noise is audible. In direct current operation, there is no noise.

Adjustable keeper (FF, FaFix)	Monitoring contact (RR)	Mechanical unlocking (E)	Diode (05)	Sliding ramp	Fail-locked	Model
•					•	118
•		•			•	118E
•	•				•	118RR
•			•		•	11805
•	•		•		•	11805RR

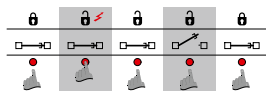

Hold-open function

The latch bolt-controlled hold-open catch in the centre of the keeper holds the strike unlocked even after a contact is made until the door is opened.

Adjustable keeper (FF, FaFix)	Mechanical unlocking (E)	Hold-open function	Model
•		•	128
•	•	•	128E

Model series 118, 128 and 138 at a glance

Standard electric strike 118, minimum fitting size - maximum effect

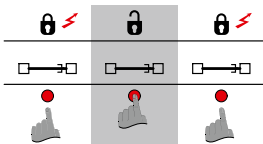

Fail-unlocked function

The strike is blocked as long as the power is switched on. Once the current is switched off or interrupted due to a power failure, the keeper can be moved and the door opened.

Adjustable keeper (FF, FaFix)	Monitoring contact (RR)	Diode (05)	Fail-unlocked	Model
•			•	138
•	•		•	138RR
•		•	•	13805
•	•	•	•	13805RR

Fail-locked 118/128

118 128 138

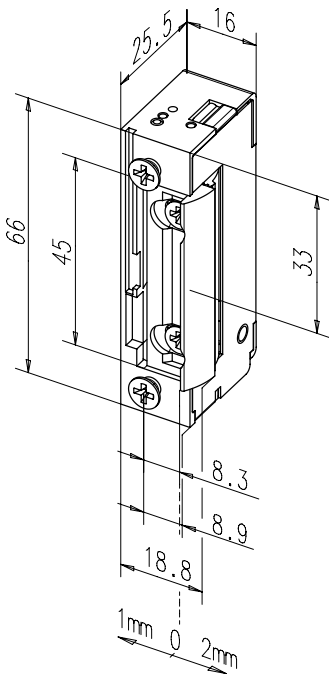

Minimum fitting size - maximum effect
effeff standard electric strike 118 with FaFix (FF)

Model with basic features.

The advantages at a glance

- Radius keeper, FaFix 3 mm adjustable
- Universal voltage
- Compatible with all current mortise locks
- Compatible with all commercially available striking plates also striking plates for plastic profiles
- Symmetrical design. DIN left/right as well as horizontal applicable

Electrical data	10-24 V AC/DC	22-42 V AC/DC
Rated resistance	43 Ω	200 Ω
AC current consumption	250 mA (12V) 500 mA (24V)	60 mA
Current consumption DC (stabilised)	280 mA (12V) 560 mA (24V)	120 mA
Max. keeper pre-load AC	200 N (12V) 250 N (24V)	200 N
Max. keeper pre-load DC (stabilised)	50 N (12V) 200 N (24V)	50 N

Characteristics	Technical attributes
Adjustable keeper (FF, FaFix)	• Break-in resistance 3750 N
Adjustable strike (F, Fix)	Height 66 mm
Monitoring contact (RR)	Width 16 mm
Mechanical unlocking (E)	Depth 25,5 mm
Diode (05)	Operating temperature range -15 °C to +40 °C
Fail-locked	• Installation position vertical and horizontal
Hold-open function	Material housing Die-cast zinc
	Material keeper Die-cast zinc
	Fafix regulating range 3 mm
	Latch bolt engaging depth 5,5 mm
	Internal works continuous function load cycles 250000

DIN directions	
Universal	1
Voltage	
10-24 V AC/DC	A7
22-42 V AC/DC	B7

Order no.
118----- ** *

Order suffix for model with hold open function = 128 -...

Standard combinations fail-locked 118/128

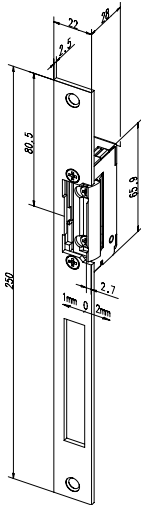

Electric strike 118 with flat striking plate 434

With 2 fixing holes, for steel doors

Technical attributes	
Colour	35
Type	HZ

DIN directions	
Universal	1

Voltage	
10-24 V AC/DC	A7
22-42 V AC/DC	B7

Order no.		
118	43435	** *

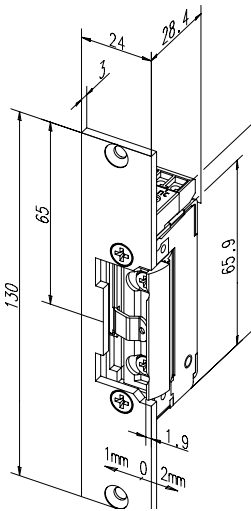

Electric strike 118 with short flat striking plate 096

With 2 fixing holes, for steel doors without dead bolt

Technical attributes	
Colour	35
Type	kl

DIN directions	
Universal	1

Voltage	
10-24 V AC/DC	A7
22-42 V AC/DC	B7

Order no.		
118	09635	** *

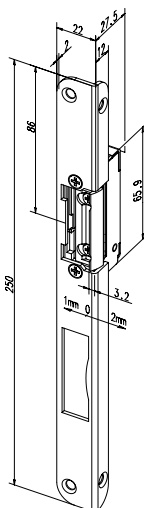

Electric strike 118 with angled striking plate 513

With 4 fixing holes, for rebated wooden doors

Technical attributes	
Colour	35
Type	iW

DIN directions	
Left	4
Right	5

Voltage	
10-24 V AC/DC	A7
22-42 V AC/DC	B7

Order no.		
118	51335	** *

Fail-unlocked 138

118 128 138

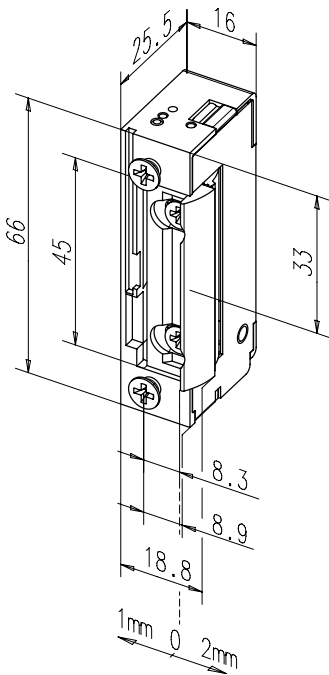

Minimum fitting size - maximum effect
effeff standard electric strike 138 with FaFix (FF)

Model with basic features.

The advantages at a glance

- Radius keeper, FaFix 3 mm adjustable
- Universal voltage
- Compatible with all current mortise locks
- Compatible with all commercially available striking plates also striking plates for plastic profiles
- Symmetrical design. DIN left/right as well as horizontal applicable

Electrical data	12 V DC	24 V DC
Rated resistance	51 Ω	160 Ω
Current consumption DC (stabilised)	235 mA	150 mA
Max. keeper pre-load DC (stabilised)	30 N	30 N

Characteristics	Technical attributes
Adjustable keeper (FF, FaFix)	• Break-in resistance 3750 N
Adjustable strike (F, Fix)	Height 66 mm
Monitoring contact (RR)	Width 16 mm
Diode (05)	Depth 25,5 mm
Fail-unlocked	• Operating temperature range -15 °C to +40 °C
Hold-open function	Installation position vertical and horizontal
	Material housing Die-cast zinc
	Material keeper Die-cast zinc
	Fafix regulating range 3 mm
	Latch bolt engaging depth 5,5 mm
	Internal works continuous function load cycles 250000

DIN directions	
Universal	1
Voltage	
12 V DC	E9
24 V DC	F9

Order no.
138----- ** *

Standard combinations fail-unlocked 138

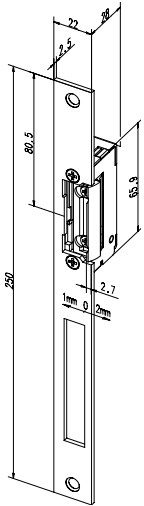

Electric strike 138 with flat striking plate 434

With 2 fixing holes, for steel doors

Technical attributes		DIN directions	
Colour	35	Universal	1
Type	HZ		
		Voltage	
		12 V DC	E9
		24 V DC	F9
Order no.			
138----		43435	** *

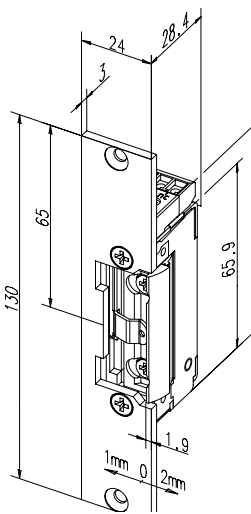

Electric strike 138 with short flat striking plate 096

With 2 fixing holes, for steel doors without dead bolt

Technical attributes		DIN directions	
Colour	35	Universal	1
Type	kl		
		Voltage	
		12 V DC	E9
		24 V DC	F9
Order no.			
138----		09635	** *

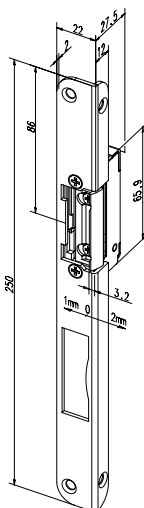

Electric strike 138 with angled striking plate 513

With 4 fixing holes, for rebated wooden doors

Technical attributes		DIN directions	
Colour	35	Left	4
Type	iW	Right	5
		Voltage	
		12 V DC	E9
		24 V DC	F9
Order no.			
138----		51335	** *

Model series 118, 128 and 138 ProFix 2 at a glance

Standard-electric strike ProFix 2

effeff-standard-electric strike 118 ProFix 2

With its dimensions of 66 mm x 16 mm x 25.5 mm, effeff door strike 118 is the smallest ProFix 2 electric strike in the world.

Model 118 is an all purpose electric strike. Its compact design enables it not only to open up doors, but also new potentials. There is also no need for you to go without standard extras such as a feedback signal contact, a hold-open function, an actuating lever and a diode. Both fail secure and fail safe modes of operation are available. The voltage range makes it easy for you to choose the voltage, thus also reducing warehousing space. The optional plug-in connection cable means connecting up is child's play and fitting thus takes even less time.

The advantages at a glance:

- Universal voltage
- Pluggable connecting cable available
- Symmetrical design. DIN left/right as well as horizontal applicable
- Optimum sliding ramp for a soft interplay with latch bolt
- Compatible to current ProFix 2 striking plates
- Usable from a x-dimension to 4 mm

What is ProFix?

Please see chapter „Technical Explanations“

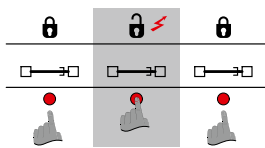

Fail locked function

The door can only be opened while a contact is made. In alternating current operation, a humming noise is audible. In direct current operation, there is no noise.

Adjustable keeper (FF, FaFix)	Monitoring contact (RR)	Mechanical unlocking (E)	Diode (05)	Fail-locked	Model
•				•	118.13
•		•		•	118E.13
•	•			•	118.23
•	•	•		•	118E.23
•			•	•	118.53
•		•	•	•	118E.53
•	•		•	•	118.63

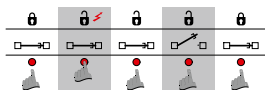

Hold-open function

The latch bolt-controlled hold-open catch in the centre of the keeper holds the strike unlocked even after a contact is made until the door is opened.

Adjustable keeper (FF, FaFix)	Mechanical unlocking (E)	Hold-open function	Model
•		•	128.13
•	•	•	128E.13

Model series 118, 128 and 138 ProFix 2 at a glance

Standard-electric strike ProFix 2

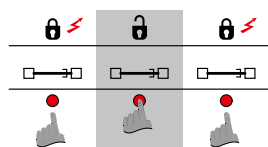

Fail-unlocked function
 The strike is blocked as long as the power is switched on. Once the current is switched off or interrupted due to a power failure, the keeper can be moved and the door opened.

Adjustable keeper (FF, FaFix)	Monitoring contact (RR)	Diode (05)	Fail-unlocked	Model
•			•	138.13
•	•		•	138.23
•		•	•	138.53
•	•	•	•	138.63

Fail-locked 118.13/128.13



Minimum fitting size - maximum effect effeff-standard-electric strike 118 ProFix 2 with FaFix (FF)

Model with basic features.

The advantages at a glance

- Compatible with all current mortise locks
- Symmetrical design. DIN left/right as well as horizontal applicable
- Optimum sliding ramp for a soft interplay with latch bolt
- Compatible to current ProFix 2 striking plates
- Usable from a x-dimension to 4 mm
- 3 mm adjustable keeper (FaFix)

Electrical data	10-24 V AC/DC	22-42 V AC/DC
Rated resistance	43 Ω	200 Ω
AC current consumption	250 mA (12V) 500 mA (24V)	60 mA
Current consumption DC (stabilised)	280 mA (12V) 560 mA (24V)	120 mA
Max. keeper pre-load AC	200 N (12V) 250 N (24V)	200 N
Max. keeper pre-load DC (stabilised)	50 N (12V) 200 N (24V)	50 N

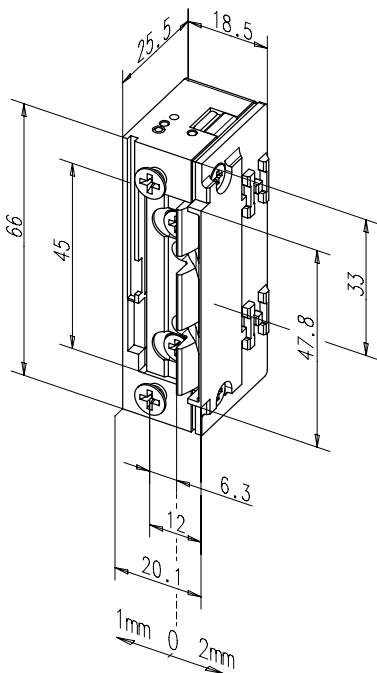

Characteristics

- Adjustable keeper (FF, FaFix)
- Adjustable strike (F, Fix)
- Monitoring contact (RR)
- Mechanical unlocking (E)
- Diode (05)
- Fail-locked
- Hold-open function

Technical attributes

- Break-in resistance: 3750 N
- Height: 66 mm
- Width: 20,1 mm
- Depth: 25,5 mm
- Operating temperature range: -15 °C to +40 °C
- Installation position: vertical and horizontal
- Fafix regulating range: 3 mm
- Latch bolt engaging depth: 5,5 mm
- Internal works continuous function load cycles: 250000

DIN directions

Universal 1

Voltage

10-24 V AC/DC A7
22-42 V AC/DC B7

Order no.

118.13----- ** *

Order suffix for model with hold open function = 128.13 -...

Standard combinations fail-locked 118.13/128.13

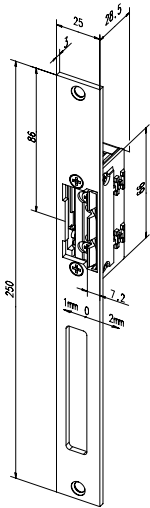

Electric strike 118.13 with flat striking plate 55A

With 2 fixing holes, for PVC and aluminium doors

Technical attributes	
Colour	35
Type	HZ

DIN directions	
Universal	1

Voltage	
10-24 V AC/DC	A7
22-42 V AC/DC	B7

Order no.		
118.13-55A35	**	*

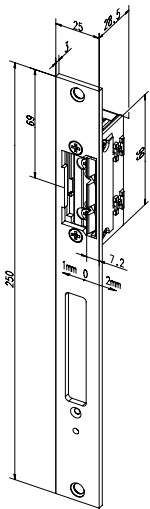

Electric strike 118.13 with flat striking plate 712 pre-equipped for bolt switching contact model 878

With 2 fixing holes, for PVC and aluminium doors

Technical attributes	
Colour	35
Type	HZ

DIN directions	
Universal	1

Voltage	
10-24 V AC/DC	A7
22-42 V AC/DC	B7

Order no.		
118.13-71235	**	*

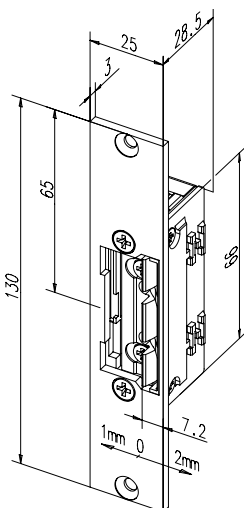

Electric strike 118.13 with short flat striking plate 688

With 2 fixing holes, for PVC and aluminium doors without dead bolt

Technical attributes	
Colour	35
Type	kF

DIN directions	
Universal	1

Voltage	
10-24 V AC/DC	A7
22-42 V AC/DC	B7

Order no.		
118.13-68835	**	*

Standard combinations fail-locked 118.13/128.13

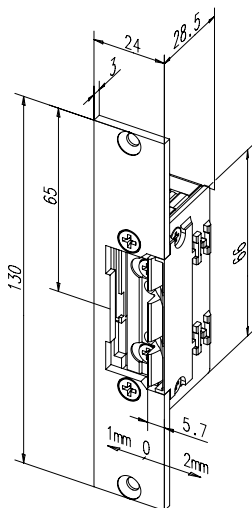

Electric strike 118.13 with short flat striking plate 689

With 2 fixing holes, for steel doors without dead bolt

Technical attributes	
Colour	35
Type	kl

DIN directions	
Universal	1

Voltage	
10-24 V AC/DC	A7
22-42 V AC/DC	B7

Order no.		
118.13-68935	**	*

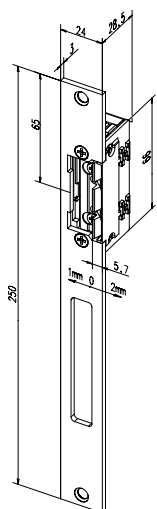

Electric strike 118.13 with flat striking plate 690

With 2 fixing holes, for steel doors

Technical attributes	
Colour	35
Type	HZ

DIN directions	
Universal	1

Voltage	
10-24 V AC/DC	A7
22-42 V AC/DC	B7

Order no.		
118.13-69035	**	*

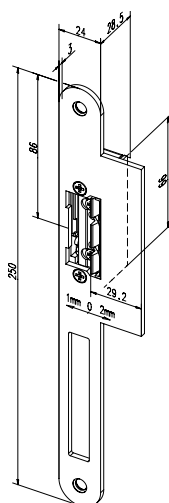

Electric strike 118.13 with flanged striking plate

With 2 fixing holes, for flush wooden doors

Technical attributes	
Colour	35
Type	Lap

DIN directions	
Universal	1

Voltage	
10-24 V AC/DC	A7
22-42 V AC/DC	B7

Order no.		
118.13-52A35	**	*

Standard combinations fail-locked 118.13/128.13

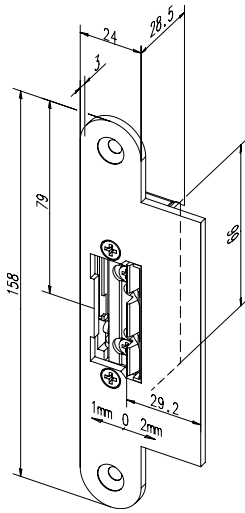

Electric strike 118.13 with short flanged striking plate 53A

With 2 fixing holes, for flush wooden doors without dead bolt

Technical attributes		DIN directions	
Colour	35	Universal	1
Type	kl		
Voltage			
10-24 V AC/DC	A7		
22-42 V AC/DC	B7		
Order no.			
118.13-53A35		**	*

Fail-unlocked 138.13

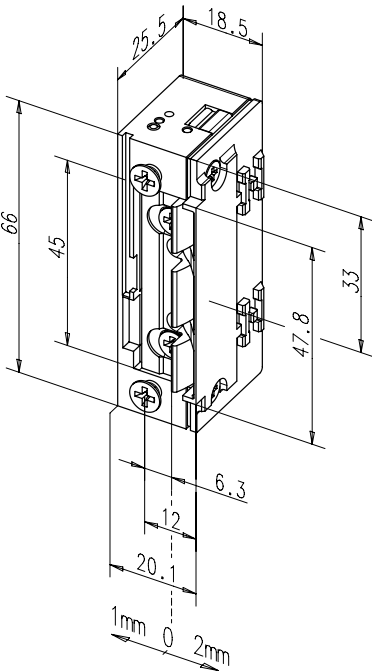
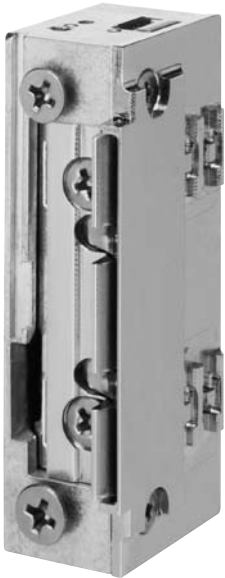

Minimum fitting size - maximum effect
effeff standard electric strike 138 ProFix 2 with FaFix (FF)

Model with basic features.

The advantages at a glance

- Compatible with all current mortise locks
- Symmetrical design. DIN left/right as well as horizontal applicable
- Optimum sliding ramp for a soft interplay with latch bolt
- Compatible to current ProFix 2 striking plates
- Usable from a x-dimension to 4 mm
- 3 mm adjustable keeper (FaFix)

Electrical data	12 V DC	24 V DC
Rated resistance	51 Ω	160 Ω
Current consumption DC (stabilised)	235 mA	150 mA
Max. keeper pre-load DC (stabilised)	30 N	30 N

Characteristics	Technical attributes
Adjustable keeper (FF, FaFix)	• Break-in resistance 3750 N
Adjustable strike (F, Fix)	• Height 66 mm
Monitoring contact (RR)	• Width 20,1 mm
Diode (05)	• Depth 25,5 mm
Fail-unlocked	• Operating temperature range -15 °C to +40 °C
Hold-open function	• Installation position vertical and horizontal
	• Fafix regulating range 3 mm
	• Latch bolt engaging depth 5,5 mm
	• Continuous function load cycles 250000

DIN directions	Order no.
Universal	1
Voltage	
12 V DC	E9
24 V DC	F9
	138.13----- ** *

116 126 136 ProFix2

Standard combinations fail-unlocked 138.13

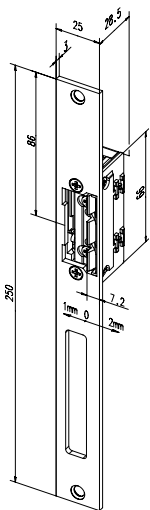

Electric strike 138.13 with flat striking plate 55A

With 2 fixing holes, for PVC and aluminium doors

Technical attributes		DIN directions	
Colour	35	Universal	1
Type	HZ		
		Voltage	
		10-24 V AC/DC	A7
		22-42 V AC/DC	B7
Order no.			
138.13-55A35		**	*

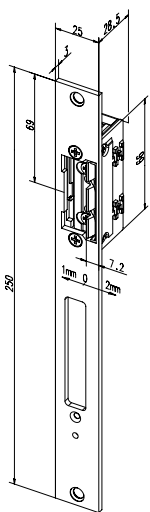

Electric strike 138.13 with flat striking plate 712

pre-equipped for bolt switching contact model 878

With 2 fixing holes, for PVC and aluminium doors

Technical attributes		DIN directions	
Colour	35	Universal	1
Type	HZ		
		Voltage	
		12 V DC	E9
		24 V DC	F9
Order no.			
138.13-71235		**	*

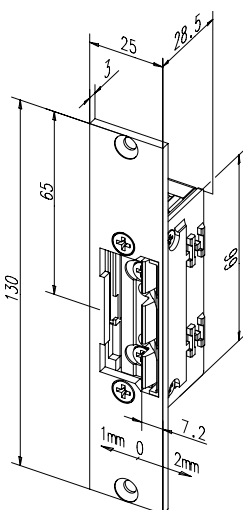

Electric strike 138.13 with short flat striking plate 688

With 2 fixing holes, for PVC and aluminium doors without dead bolt

Technical attributes		DIN directions	
Colour	35	Universal	1
Type	kF		
		Voltage	
		12 V DC	E9
		24 V DC	F9
Order no.			
138.13-68835		**	*

Standard combinations fail-unlocked 138.13

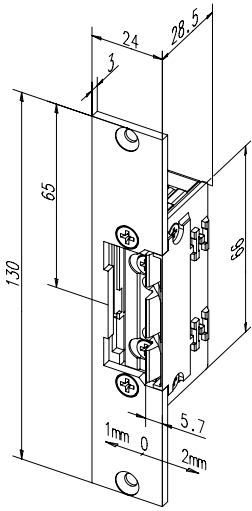

Electric strike 138.13 with short flat striking plate 689

With 2 fixing holes, for steel doors without dead bolt

Technical attributes		DIN directions	
Colour	35	Universal	1
Type	kl		
		Voltage	
		12 V DC	E9
		24 V DC	F9
			↓ ↓
Order no.			
138.13-68935		**	*

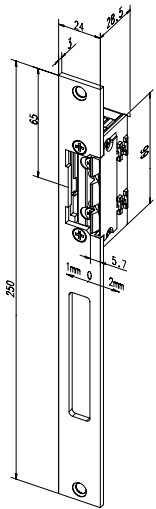

Electric strike 138.13 with flat striking plate 690

With 2 fixing holes, for steel doors

Technical attributes		DIN directions	
Colour	35	Universal	1
Type	HZ		
		Voltage	
		12 V DC	E9
		24 V DC	F9
			↓ ↓
Order no.			
138.13-69035		**	*

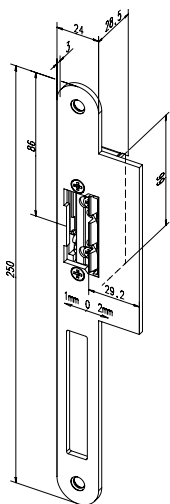

Electric strike 138.13 with flanged striking plate 52A

With 2 fixing holes, for flush wooden doors

Technical attributes		DIN directions	
Colour	35	Universal	1
Type	Lap		
		Voltage	
		10-24 V AC/DC	A7
		22-42 V AC/DC	B7
			↓ ↓
Order no.			
138.13-52A35		**	*

Standard combinations fail-unlocked 138.13

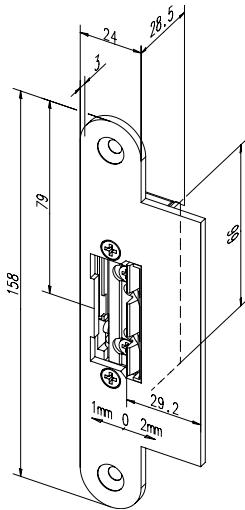

Electric strike 138.13 with short flanged striking plate 53A

With 2 fixing holes, for flush wooden doors without dead bolt

Technical attributes		DIN directions	
Colour	35	Universal	1
Type	kl		
Voltage			
		10-24 V AC/DC	A7
		22-42 V AC/DC	B7
Order no.			
138.13-53A35		**	*

ProFix 1 model series 116, 126 and 136 at a glance

The universal electric strike with radius latch in version ProFix 1

The universal electric strike with radius latch in version ProFix 1

ProFix is a combination of a FaFix strike with latch bolt guide (sliding ramp). In order to make the advantages of the radius strike and FaFix fully available to the user, effeff has developed ProFix. The frame recess/ door frame cutout can be standardised with ProFix.

The advantages at a glance:

- Applicable for all current ProFix striking plates
- Can be mounted DIN right or left by turning over 180°
- Symmetrical design

What is ProFix?

Please see chapter „Technical Explanations“

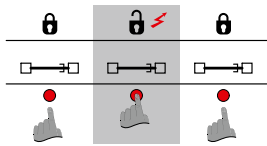

Fail locked function

The door can only be opened while a contact is made. In alternating current operation, a humming noise is audible. In direct current operation, there is no noise.

Adjustable keeper (FF, FaFix)	Monitoring contact (RR)	Mechanical unlocking (E)	Diode (05)	Angeled face plate	Fail-locked	Model
•					•	116.10
•		•			•	116E.10
•	•				•	116.20
•			•		•	116.50
•	•		•		•	116.60
•				•	•	116.11
•		•		•	•	116E.11
•	•			•	•	116.21
•			•	•	•	116.51
•	•		•	•	•	116.61

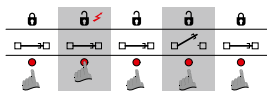

Hold-open function

The latch bolt-controlled hold-open catch in the centre of the keeper holds the strike unlocked even after a contact is made until the door is opened.

Adjustable keeper FF, FaFix)	Mechanical unlocking (E)	Hold-open function	Angeled face plate	Model
•		•		126.10
•	•	•		126E.10
•		•	•	126.11
•	•	•	•	126E.11

ProFix 1 model series 116, 126 and 136 at a glance

The universal electric strike with radius latch in version ProFix 1

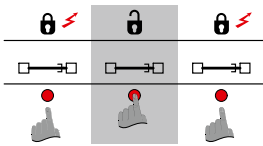

Fail-unlocked function

The strike is blocked as long as the power is switched on. Once the current is switched off or interrupted due to a power failure, the keeper can be moved and the door opened.

Adjustable keeper (FF, FaFix)	Monitoring contact (RR)	Diode (05)	Fail-unlocked	Angeled face plate	Model
•			•		136.10
•		•	•		136.50
•	•	•	•		136.60
•			•	•	136.11
•	•		•	•	136.21
•		•	•	•	136.51
•	•	•	•	•	136.61

Fail-locked 116.10

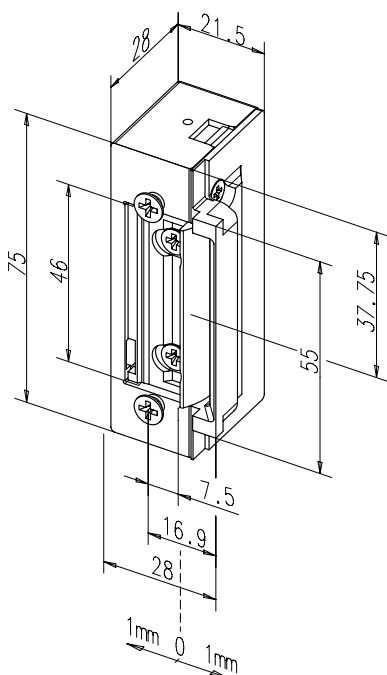

The universal electric strike in ProFix 1 version with radius latch and FaFix (FF)
Model with basic features.

The advantages at a glance

- Applicable for ProFix flat striking plates
- Can be mounted DIN right or left by turning over 180°
- Symmetrical design

Electrical data	6-12 V AC/DC	8-16 V AC/DC	12 V 100% ED	24 V 100% ED
Rated resistance	9,1 Ω	22 Ω	44 Ω	200 Ω
AC current consumption	550 mA (6V) 1100 mA (12V)	310 mA (8V) 470 mA (12V) 620 mA (16V)	-	-
Current consumption DC (stabilised)	660 mA (6V) 1300 mA (12V)	360 mA (8V) 550 mA (12V) 730 mA (16V)	270 mA	235 mA
Operating noise during AC use	5	5 (8V) 4 (12V) 4 (16V)	-	-
Max. keeper pre-load AC	160 N	10 N (8V) 160 N (12V) 160 N (16V)	-	-
Max. keeper pre-load DC (stabilised)	10 N (6V) 90 N (12V)	10 N (8V) 50 N (12V) 100 N (16V)	30 N	10 N

Characteristics

- Adjustable keeper (FF, FaFix)
- Adjustable strike (F, Fix)
- Monitoring contact (RR)
- Mechanical unlocking (E)
- Diode (O5)
- Fail-locked
- Hold-open function

Technical attributes

- Break-in resistance: 5000 N
- Height: 75 mm
- Width: 21,5 mm
- Depth: 28 mm
- Operating temperature range: -15 °C to +40 °C
- Installation position: vertical and horizontal
- Material housing: Die-cast zinc
- Material keeper: Die-cast zinc
- Material surface-mounted attachment: Die-cast zinc

DIN directions

Universal	1
Voltage	
6-12 V AC/DC	D1
8-16 V AC/DC	R1
24 V AC/DC	F1
12 V 100% ED	E4
24 V 100% ED	F4

Order no.

116.10----- ** *

Standard combinations fail-locked 116.10

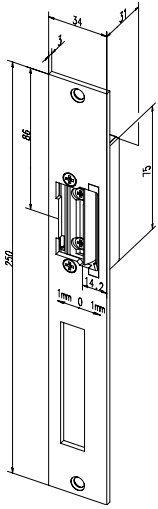

Electric strike 116.10 with flat striking plate 520

With 2 fixing holes, for PVC and aluminium doors

Technical attributes		DIN directions	
Colour	35	Universal	1
Type	HZF		
Voltage			
6-12 V AC/DC	D1		
8-16 V AC/DC	R1		
24 V AC/DC	F1		
12 V 100% ED	E4		
24 V 100% ED	F4		
Order no.			
116.10-52035		**	*

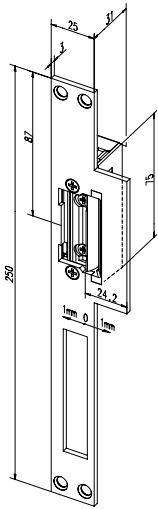

Electric strike 116.10 with flat striking plate 521

With 4 fixing holes, for flush wooden door

Technical attributes		DIN directions	
Colour	35	Universal	1
Type	Lap		
Voltage			
6-12 V AC/DC	D1		
8-16 V AC/DC	R1		
24 V AC/DC	F1		
12 V 100% ED	E4		
24 V 100% ED	F4		
Order no.			
116.10-52135		**	*

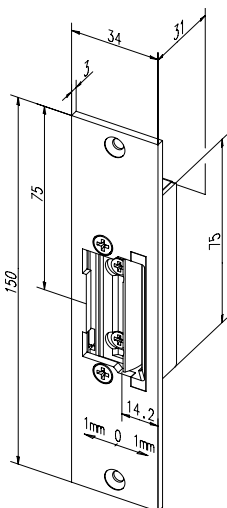

Electric strike 116.10 with short flat striking plate 522

With 2 fixing holes, for PVC and aluminium doors without dead bolt

Technical attributes		DIN directions	
Colour	35	Universal	1
Type	kF		
Voltage			
6-12 V AC/DC	D1		
8-16 V AC/DC	R1		
24 V AC/DC	F1		
12 V 100% ED	E4		
24 V 100% ED	F4		
Order no.			
116.10-52235		**	*

Fail-locked 116.11/126.11

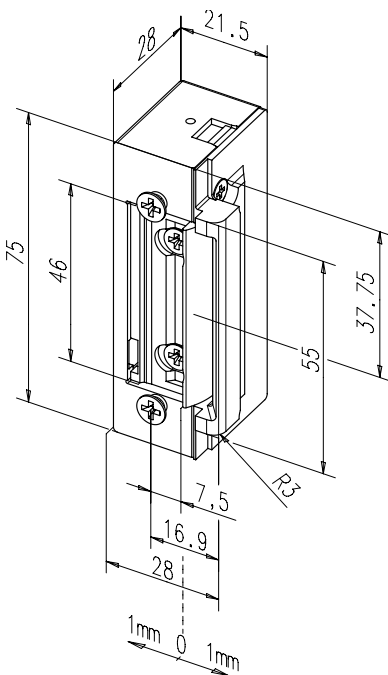
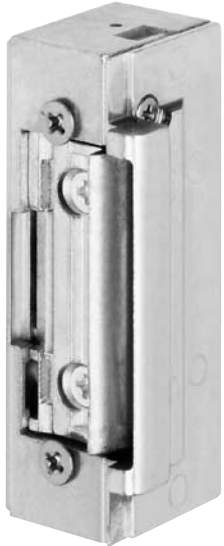

The universal electric strike in ProFix 1 version with radius latch and FaFix (FF)

Model with basic features for ProFix angled striking plates

The advantages at a glance

- Applicable for ProFix angled striking plates
- Symmetrical design

Electrical data	6-12 V AC/DC	8-16 V AC/DC	12 V 100% ED	24 V 100% ED
Rated resistance	9,1 Ω	22 Ω	44 Ω	200 Ω
AC current consumption	550 mA (6V) 1100 mA (12V)	310 mA (8V) 470 mA (12V) 620 mA (16V)	-	-
Current consumption DC (stabilised)	660 mA (6V) 1300 mA (12V)	360 mA (8V) 550 mA (12V) 730 mA (16V)	270 mA	120 mA
Operating noise during AC use	5	5 (8V) 4 (12V) 4 (16V)	-	-
Max. keeper pre-load AC	160 N	10 N (8V) 160 N (12V) 160 N (16V)	-	-
Max. keeper pre-load DC (stabilised)	10 N (6V) 90 N (12V)	10 N (8V) 50 N (12V) 100 N (16V)	30 N	10 N

Characteristics	Technical attributes
Adjustable keeper (FF, FaFix)	• Break-in resistance 5000 N
Adjustable strike (F, Fix)	Height 75 mm
Monitoring contact (RR)	Width 21,5 mm
Mechanical unlocking (E)	Depth 28 mm
Diode (O5)	Operating temperature range -15 °C to +40 °C
Fail-locked	• Installation position vertical and horizontal
Hold-open function	Material housing Die-cast zinc
	Material keeper Die-cast zinc

DIN directions	
Universal	1
Voltage	
6-12 V AC/DC	D1
8-16 V AC/DC	R1
24 V AC/DC	F1
12 V 100% ED	E4
24 V 100% ED	F4
Order no.	
116.11 -----	** *

Order suffix for model with hold open function = 126.11 -...

Standard combinations fail-locked 116.11/126.11

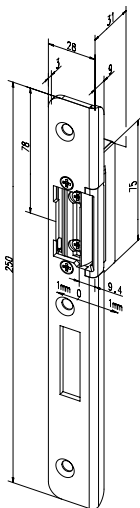

Electric strike 116.11 with angled striking plate 525

With 2 fixing holes, for rebated wooden doors

Technical attributes		DIN directions	
Colour	35	Left	4
Type	iW	Right	5
		Voltage	
		6-12 V AC/DC	D1
		8-16 V AC/DC	R1
		24 V AC/DC	F1
		12 V 100% ED	E4
		24 V 100% ED	F4
Order no.			
116.11-52535		**	*

Fail-unlocked 136.10

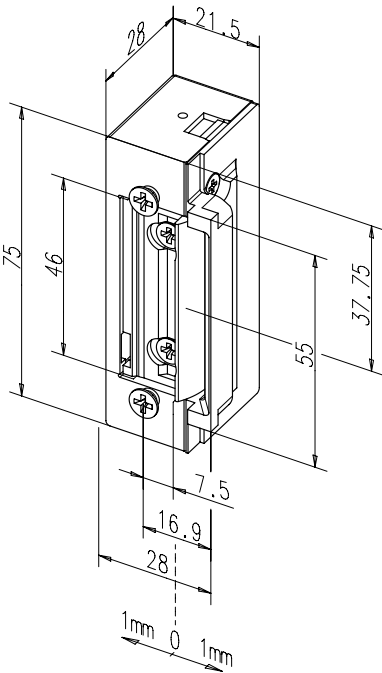

The universal electric strike in ProFix 1 version with radius latch and FaFix (FF) Model with basic features.

The advantages at a glance

- Applicable for ProFix flat striking plates
- Can be mounted DIN right or left by turning over 180°
- Symmetrical design

Electrical data	12 V DC	24 V DC
Rated resistance	9,1Ω	160 Ω
Current consumption DC (stabilised)	235 mA	150 mA
Max. keeper pre-load DC (stabilised)	10 N	10 N

Characteristics	Technical attributes	
Adjustable keeper (FF, FaFix)	Break-in resistance	5000 N
Adjustable strike (F, Fix)	Height	75 mm
Monitoring contact (RR)	Width	20,5 mm
Diode (05)	Depth	28 mm
Fail-unlocked	Operating temperature range	-15 °C to +40 °C
Hold-open function	Installation position	vertical and horizontal
	Material housing	Die-cast zinc
	Material keeper	Die-cast zinc
	Material surface-mounted attachment	Die-cast zinc

DIN directions	
Universal	1

Voltage	
12 V DC	E9
24 V DC	F9

Order no.	
136.10-----	** *

Standard combinations fail-unlocked 136.10

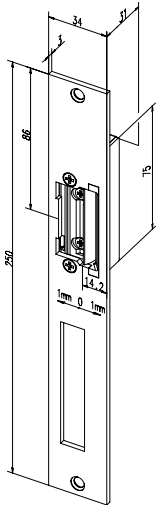

Electric strike 136.10 with flat striking plate 520

With 2 fixing holes, for PVC and aluminium doors

Technical attributes	
Colour	35
Type	HZF

DIN directions	
Universal	1

Voltage	
12 V DC	E9
24 V DC	F9

Order no.		
136.10-52035	**	*

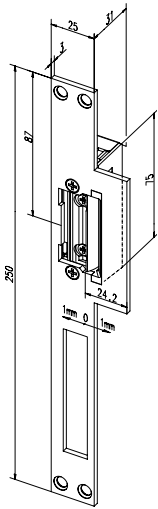

Electric strike 136.10 with flat striking plate 521

With 4 fixing holes, for flush wooden doors

Technical attributes	
Colour	35
Type	Lap

DIN directions	
Universal	1

Voltage	
12 V DC	E9
24 V DC	F9

Order no.		
136.10-52135	**	*

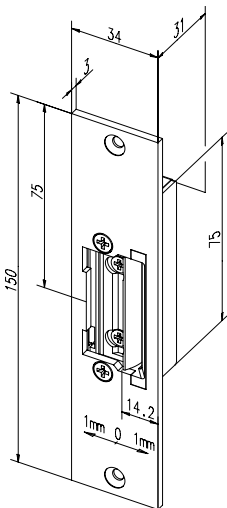

Electric strike 136.10 with short striking plate 522

With 2 fixing holes, for PVC and aluminium doors without dead bolt

Technical attributes	
Colour	35
Type	kF

DIN directions	
Universal	1

Voltage	
12 V DC	E9
24 V DC	F9

Order no.		
136.10-52235	**	*

Fail-unlocked 136.11

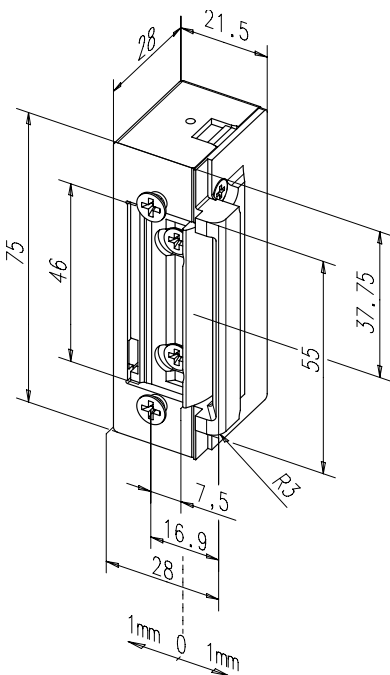
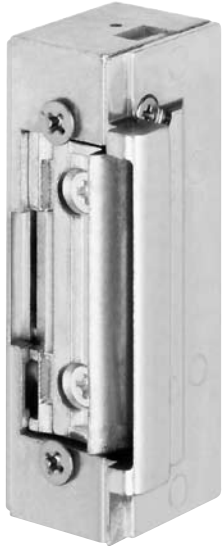

The universal electric strike in ProFix 1 version with radius latch and FaFix (FF)
Model with basic features for ProFix angled striking plates

The advantages at a glance

- Applicable for ProFix angled striking plates
- Can be mounted DIN right or left by turning over 180°
- Symmetrical design

Electrical data	12 V DC	24 V DC
Rated resistance	51 Ω	160 Ω
Current consumption DC (stabilised)	235 mA	150 mA
Max. keeper pre-load DC (stabilised)	10 N	10 N

Characteristics	Technical attributes	
Adjustable keeper (FF, FaFix)	• Break-in resistance	5000 N
Adjustable strike (F, Fix)	Height	75 mm
Monitoring contact (RR)	Width	20,5 mm
Mechanical unlocking (E)	Depth	28 mm
Diode (05)	Operating temperature range	-15 °C to +40 °C
Fail-unlocked	• Installation position	vertical and horizontal
Hold-open function	Material housing	Die-cast zinc
	Material keeper	Die-cast zinc
	Material surface-mounted attachment	Die-cast zinc

DIN directions	Order no.
Universal	1
Voltage	
12 V DC	E9
24 V DC	F9
	↓ ↓
	136.11----- ** *

Fail-unlocked 136.11

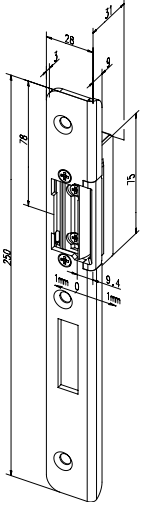

Electric strike 136.11 with angled striking plate 525

With 2 fixing holes, for rebated wooden doors

Technical attributes

Colour	35
Type	iW

DIN directions

Left	4
Right	5

Voltage

12 V DC	E9
24 V DC	F9

Order no.

136.11-52535	**	*
--------------	----	---

Model series 12, 22 and 32 at a glance

Water-resistant electric strikes

The advantages at a glance:

- Water-proof for use outdoors
- Suitable for all commonly used striking plates

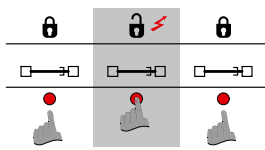

Fail locked function

The door can only be opened while a contact is made. In alternating current operation, a humming noise is audible. In direct current operation, there is no noise.

Adjustable strike (F, Fix)	Monitoring contact (RR)	Mechanical unlocking (E)	Diode (05)	Connecting cable (KAB)	Strike for rim lock	Rim-type housing	Water-resistant	Fail-locked	Model
•							•	•	12F
•		•					•	•	12EF
•	•						•	•	12RRF
•	•	•					•	•	12RREF
•			•				•	•	1205F
•		•	•				•	•	1205EF
•	•		•				•	•	1205RRF

12 22 32

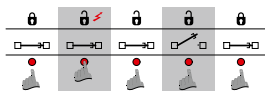

Hold-open function

The latch bolt-controlled hold-open catch in the centre of the keeper holds the strike unlocked even after a contact is made until the door is opened.

Adjustable keeper (FF, FaFix)	Adjustable strike (F, Fix)	Monitoring contact (RR)	Mechanical unlocking (E)	Diode (05)	Connecting cable (KAB)	Rim-type housing	Water-resistant	Hold-open function	Model
	•						•	•	22F
	•		•				•	•	22EF
	•	•					•	•	22RRF
	•	•	•				•	•	22RREF
	•			•			•	•	2205F
	•	•		•			•	•	2205RRF

Model series 12, 22 and 32 at a glance

Water-resistant electric strikes

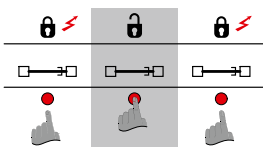

Fail-unlocked function

The strike is blocked as long as the power is switched on. Once the current is switched off or interrupted due to a power failure, the keeper can be moved and the door opened.

Adjustable strike (F, Fix)	Monitoring contact (RR)	Mechanical unlocking (E)	Diode (05)	Connecting cable (KAB)	Rim-type housing	Water-resistant	Fail-unlocked	Model
•						•	•	32F
•	•					•	•	32RRF
•			•			•	•	3205F
•	•		•			•	•	3205RRF

Fail locked 12F/22F

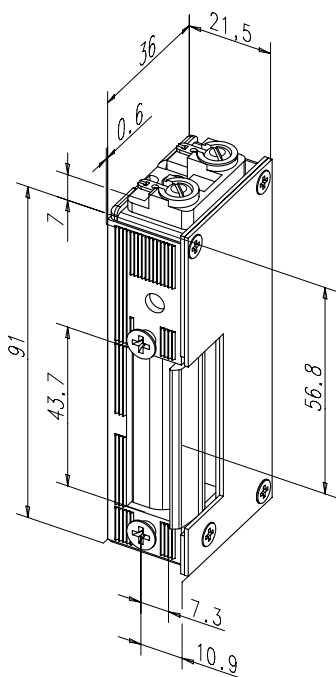

Water-resistant electric strikes

The model offers you an adjustable function and therefore an ideal way to simplify the mounting of a strike.

The advantages at a glance

- Water-proof for use outdoors
- Adjustable (FIX)
- Adjusting screw for mechanical unlocking

Electrical data	6-12 V AC/DC	8-16 V AC/DC	24 V AC/DC	12 V DC eE	24 V DC eE
Rated resistance	7,7 Ω	16,5 Ω	59 Ω	60 Ω	235 Ω
AC current consumption	550 mA (6V) 1100 mA (12V)	350 mA (8V) 700 mA (16V)	370 mA	130 mA	70 mA
Current consumption DC (stabilised)	780 mA (6V) 1560 mA (12V)	485 mA (8V) 970 mA (16V)	410 mA	200 mA	105 mA
Operating noise during AC use	4	4	-	3	4
Max. keeper pre-load AC	40 N (6V) 150 N (12V)	50 N (8V) 80 N (16V)	-	80 N	50
Max. keeper pre-load DC (stabilised)	20 N (6V) 30 N (12V)	10 N (8V) 10 N (16V)	-	20 N	20

Characteristics	Technical attributes
Adjustable keeper (FF, FaFix)	Break-in resistance 3000 N
Adjustable strike (F, Fix)	Height 100 mm
Monitoring contact (RR)	Width 37 mm
Mechanical unlocking (E)	Depth 21,5 mm
Diode (05)	Operating temperature range -20 °C to +40 °C
Fail-locked	Installation position vertical and horizontal
Hold-open function	Material housing Die-cast zinc
Water-resistant	Material keeper Brass

DIN directions	
Left	4
Right	5

Voltage	
6-12 V AC/DC	D1
8-16 V AC/DC	R1
24 V AC/DC	F1
12 V DC eE	E3
24 V DC eE	F3

Order no.	
12F-----	** *

Order suffix for model with hold open function = 12F -...

12 22 32

Standard combinations fail-locked 12F/22F

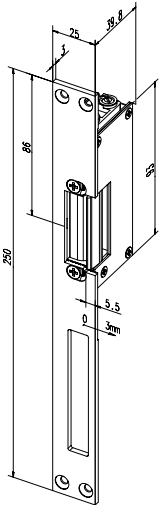

Electric strike 12F with long flat striking plate 051

With 4 fixing holes, for steel frames

Technical attributes		DIN directions	
Colour	35	Left	4
Type	HZ_fix	Right	5
		Voltage	
		6-12 V AC/DC	D1
		8-16 V AC/DC	R1
		24 V AC/DC	F1
		12 V DC eE	E3
		24 V DC eE	F3
		Order no.	
		12F---05135	** *

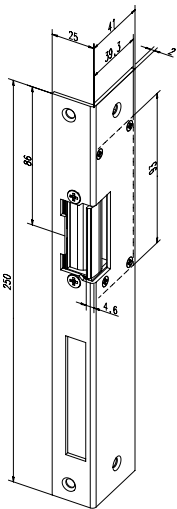

Electric strike 12 with angled striking plate 062

With 2 fixing holes, for wooden frames

Technical attributes		DIN directions	
Colour	35	Left	4
Type	iW	Right	5
		Voltage	
		6-12 V AC/DC	D1
		8-16 V AC/DC	R1
		24 V AC/DC	F1
		12 V DC eE	E3
		24 V DC eE	F3
		Order no.	
		12-----06235	** *

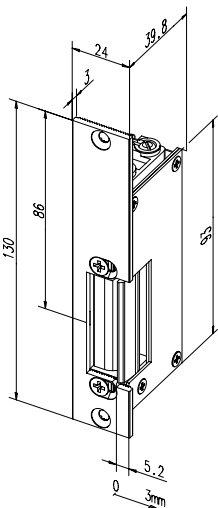

Electric strike 12F with short flat striking plate 152

With 2 fixing holes, for steel frames without dead bolt

Technical attributes		DIN directions	
Colour	35	Left	4
Type	kl_fix	Right	5
		Voltage	
		6-12 V AC/DC	D1
		8-16 V AC/DC	R1
		24 V AC/DC	F1
		12 V DC eE	E3
		24 V DC eE	F3
		Order no.	
		12F---15235	** *

Fail-unlocked 32F

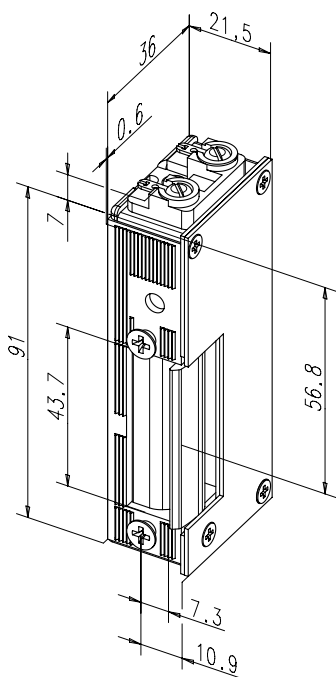

Water-resistant electric strikes

The model offers you an adjustable function and therefore an ideal way to simplify the mounting of a strike.

The advantages at a glance

- Water-proof for use outdoors
- Adjustable (FIX)
- Adjusting screw for mechanical unlocking

Electrical data	12 V DC	24 V DC
Rated resistance	61 Ω	200 Ω
Current consumption DC (stabilised)	195 mA	120 mA
Operating noise during AC use	4	4
Operating noise during DC use	0	0

Characteristics

Adjustable keeper (FF, FaFix)	
Adjustable strike (F, Fix)	•
Monitoring contact (RR)	
Diode (05)	
Fail-unlocked	•
Water-resistant	•

Technical attributes

Break-in resistance	3000 N
Height	100 mm
Width	37 mm
Depth	21,5 mm
Operating temperature range	-20 °C to +40 °C
Installation position	vertical and horizontal
Material housing	Die-cast zinc
Material keeper	Brass

DIN directions

Left	4
Right	5

Voltage

12 V DC	E9
24 V DC	F9

Order no.

32F----- ** *

Standard combinations fail-unlocked 32F

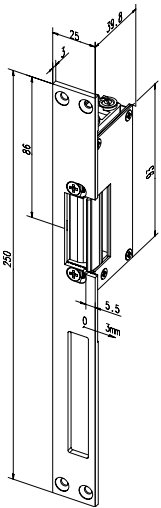

Electric strike 32F with long flat striking plate 051

With 4 fixing holes, for steel frames

Technical attributes		DIN directions	
Colour	35	Left	4
Type	HZ_fix	Right	5
		Voltage	
		12 V DC	E9
		24 V DC	F9
Order no.			
32F----05135 ** *			

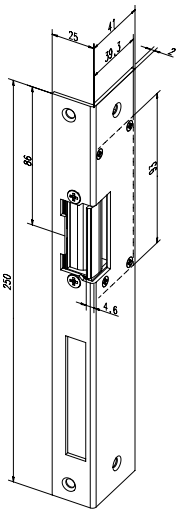

Electric strike 32 with angled striking plate 062

With 2 fixing holes, for wooden frames

Technical attributes		DIN directions	
Colour	35	Left	4
Type	iW	Right	5
		Voltage	
		12 V DC	E9
		24 V DC	F9
Order no.			
32-----06235 ** *			

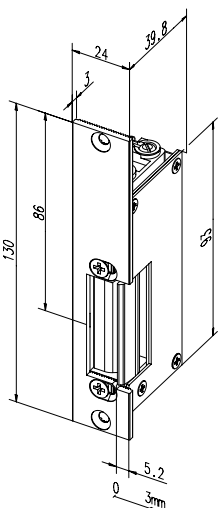

Electric strike 32F with short flat striking plate 152

With 2 fixing holes, for steel frames without dead bolt

Technical attributes		DIN directions	
Colour	35	Left	4
Type	kl_fix	Right	5
		Voltage	
		12 V DC	E9
		24 V DC	F9
Order no.			
32F----15235 ** *			

Accessories



Mortise latch model 802

Small, easily mounted version. Is used for example as an additional locking mechanism in combination with fail unlocked electric strikes.

Technical attributes

Height	55 mm
Width	20 mm
Depth	30 mm

Feature

Mortise latch	802-----00
---------------	------------

Order no.



Connection cable model 760-14

Connecting cable for standard electric strike.

Technical attributes

Number of wires	2-wire
-----------------	--------

Feature

4,5 m connection lead	760-14-----00
-----------------------	---------------

Order no.



Throw-open spring model 1020

For strikes with standard function (1-types). After contacting, the door is pushed ajar.

Technical attributes

Actuation force	10 N +/- 15 %
Actuation distance	4 mm
Height	162 mm
Width	10 mm

Feature

Throw-open spring	1020-----00
-------------------	-------------

Order no.



Press-open bolt model 1021

For strikes with standard function (1-types). After contacting, the door is pushed ajar.

Technical attributes

Actuation force	25 N +/- 15 %
Diameter	12 mm
Actuation distance	8 mm
Height	25 mm
Width	12 mm

Feature

Throw-open bolt	1021-----00
-----------------	-------------

Order no.



Press-open bolt model 1022

For strikes with standard function (1-types). After contacting, the door is pushed ajar.

Technical attributes

Actuation force	45 N +/- 15 %
Actuation distance	6 mm
Height	28,5 mm

Feature

Throw-open bolt	1022-----00
-----------------	-------------

Order no.

Accessories



Press-open bolt model 1023

For strikes with standard function (1-types). After contacting, the door is pushed ajar.

Technical attributes	
Actuation force	70 N +/- 15 %
Actuation distance	10 mm
Height	55 mm
Width	20 mm
Depth	30 mm

Feature	Order no.
Throw-open bolt	1023-----00



Automatic door strike control model 750

Automatic door strike control for unimpeded passage for the general public despite a locked door.

Technical attributes	
Mounting type	Surface-mounted/distributor installation
Adjustable waiting time	Approx. 1 to 20 sec
Adjustable strike release time	Approx. 1 to 10 sec
Height	98 mm
Width	88 mm
Depth	63 mm
Operating voltage	8 - 12 V AC

Feature	Order no.
Automatic door strike control	750-----00



Bolt switching contact model 878

Due to the switching lever mounted in rotary bearings, there is no limit to the penetration of the dead bolt. The narrow design and the supplied mounting screw permit the bolt switch contact to be mounted in existing steel frames without striking plate through the bolt cut-out. This facility permits retrofitting also in already installed frames.

Technical attributes	
Switching contact	Change-over contact
Bolt throw	nonrestricted
Class of protection	IP 54
Response path	3 mm
Connecting cable	4 m
Switching current	1,5 A
Max. switching voltage	25 V AC/DC

Feature	Order no.
3 wire	878-----00



Bolt switching contact model 875-10

Due to the closed form of the housing, the back of the dead bolt cutout is closed again, particularly in the case of steel frames and profiles. The inside of the profile is not visible. The bolt switch contact is first mounted on the striking plate, then the striking plate is mounted on the frame.

Technical attributes	
Switching contact	Change-over contact
Class of protection	IP 54
Response path	4 mm
Dead bolt penetration	15 mm
Connecting cable	4 m
Switching current	1,5 A
Max. switching voltage	25 V AC/DC

Feature	Order no.
Without striking plate	875-10-----00

Accessories



Digital time switch model 2032

Time switches are a practical and highly flexible control device for the automatic locking and unlocking of doors. The internal clock permits the door release function to be automatically switched on and off, as the time switch controls the electric strike by means of a permanent contact. With microcomputer, combined day and week-based program, 56 freely programmable locations.

Technical attributes	
Mounting type	Surface-mounted/distributor installation
Class of protection	IP 20
Width	35,8 mm
Height	90 mm
Depth	68,5 mm
Shortest switching interval	1 Min.
Power reserve	10 years
Memory locations	56 freely programmable locations
Operating voltage	230 V AC
Floating switchover contact	Max. 16 A / 250 V AC

Feature	Order no.
Day and week-based program	2032-10-----00



Bridge rectifier model 1005-10

For operation with electric strikes with alternating voltage, where no buzzing tone is wanted at permanent locking (eE, 100 % ED).

Technical attributes	
Length	14 mm
Width	14 mm
Height	11,5 mm
Length of connection slots	150 mm
Rated operating voltage	6 - 24 V AC
Current max. 100% duty cycle	0,5 A
Current max. 10 secs	1,4 A

Feature	Order no.
Bridge rectifier	1005-10-----00



Rectifier unit model 1001

The power supplies have an AC-output as well as a DC-output (DC 50% residual ripple). Therefore they offer an optimal basis for the voltage supply of electric strikes.

Technical attributes	
Rated current	1 A max. 1,5 A for 10s
Mounting type	Surface-mounted / top hat rail
Overload protection	thermal circuit breaker
Length	106 mm
Width	70 mm
Height	73 mm
Rated operating voltage primary	230 V AC

Feature	Order no.
Rated secondary voltage 12 V AC/DC	1001-12-1----00
Rated secondary voltage 24 V AC/DC	1001-24-1----00

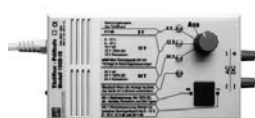

Testing transformer model 1000

For testing electric strikes and mini door code units, drop bolts and motorized bolt control systems. Output can be switched over for direct and alternating voltage. Including 2 test cables with terminals.

Technical attributes	
Operating voltage	230 V / 50 Hz
Output voltage	8 - 12 - 24 V / 1 A AC/DC

Feature	Order no.
Testing set	1000-10-----00

Accessories



Connecting cable model 760

Connecting cable for electric strike 118.

Technical attributes

Connecting cable	2-wire
------------------	--------

Feature

Feature	Order no.
1,5 m connection lead	760-150-----00
2,5 m connection lead	760-250-----00
4,5 m connection lead	760-450-----00



Screw-on mounting plates model SET-LA-M4

For flush mounting of striking plates especially in steel frames

Technical attributes

Version	angular
Threaded hole	M4

Feature

Feature	Order no.
Angular; set of 2	SET-LA-M4---00



Screw-on mounting plates model SET-LA-M5

For flush mounting of striking plates especially in steel frames

Technical attributes

Version	Radius
Threaded hole	M5

Feature

Feature	Order no.
Radius; set of 2	SET-LA-M5---00

Dummy components

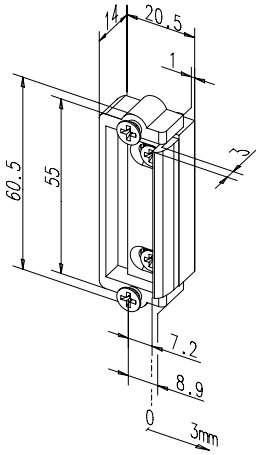

Replacement part 1410

Replacement part without electric function, with adjustable keeper (FaFix). DIN left and DIN right usable.

Technical Attributes

Height	60,5 mm
Width	19,5 mm
Depth	17 mm

Best. Nr.

1410-----00

- In preparation for model series 14,17,116

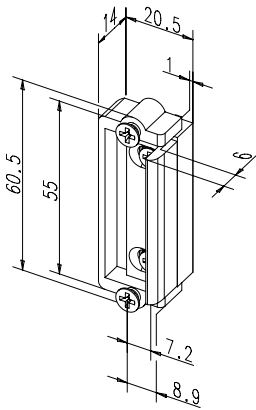

Replacement part 1410-4

Replacement part without electric function, with adjustable keeper (FaFix) and 3 mm protruding keeper. DIN left and DIN right usable.

Technical Attributes

Height	60,5 mm
Width	19,5 mm
Depth	20 mm

Best. Nr.

1410-4-----00

- In preparation for model series 14,17,116

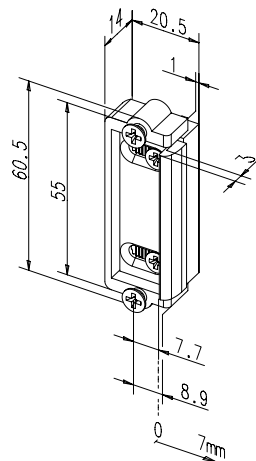

Replacement part 1410-7

Replacement part without electric function, with adjustable keeper (FaFix). DIN left and DIN right usable.

Technical Attributes

Height	60,5 mm
Width	19,5 mm
Depth	17 mm

Best. Nr.

1410-7-----00

- In preparation for model series 14,17,116

Dummy components

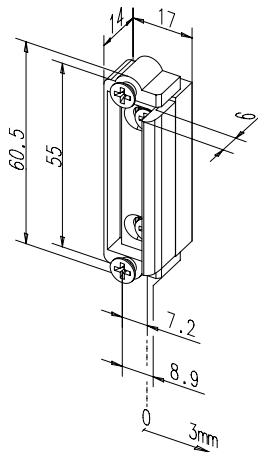

Replacement part 1410-28

Replacement part without electric function, with adjustable keeper (FaFix) and 3 mm protruding keeper. DIN left and DIN right usable.

Technical Attributes

Height	60,5 mm
Width	16 mm
Depth	20 mm

Best. Nr.

1410-28-----00

- In preparation for model series 19,119,118 with extended surface-mounted attachment

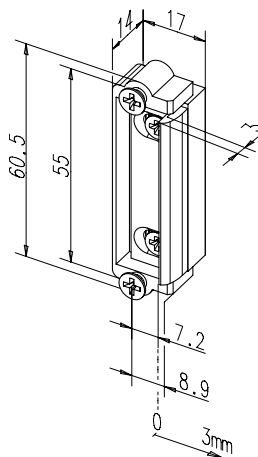

Replacement part 1410-14

Replacement part without electric function, with adjustable keeper (FaFix). DIN left and DIN right usable.

Technical Attributes

Height	60,5 mm
Width	16 mm
Depth	17 mm

Best. Nr.

1410-14-----00

- In preparation for model series 19,119,118

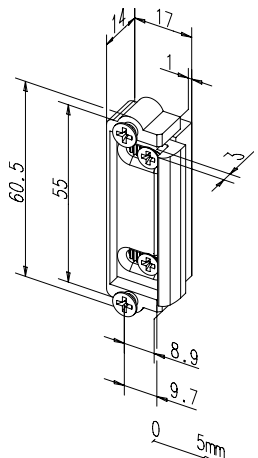

Replacement part 1410-39

Replacement part without electric function, with adjustable keeper (FaFix). DIN left and DIN right usable.

Technical Attributes

Height	60,5 mm
Width	16 mm
Depth	17 mm

Best. Nr.

1410-39-----00

- In preparation for model series 19,119,118

Dummy components

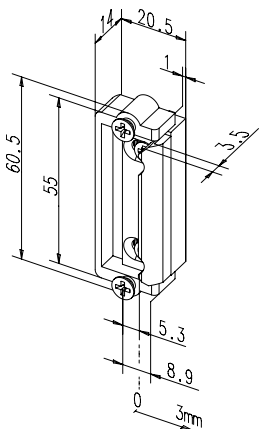

Replacement part 1410-45

Replacement part without electric function, with adjustable keeper (FaFix). DIN left and DIN right usable.

Technical Attributes

Height	60,5 mm
Width	19,5 mm
Depth	17,5 mm

Best. Nr.

1410-45-----00

- In preparation for model series 14,17,116

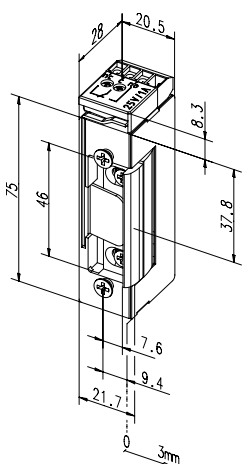

Replacement part 1410RR

Door strike without electric function, with adjustable keeper (FaFix) and electric monitoring contact.

Technical Attributes

Height	83 mm
Width	20,5 mm
Depth	31,5 mm

Best. Nr.

1410RR-----00

- In preparation for model series 14,17,116

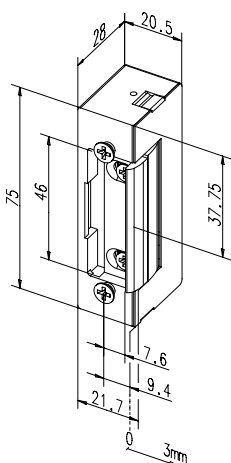

Replacement part 1410E

Door strike without electric function, with adjustable keeper (FaFix) and mechanical unlocking.

Technical Attributes

Height	75 mm
Width	20,5 mm
Depth	28 mm

Best. Nr.

1410E-----00

- In preparation for model series 14,17,116

Dummy components

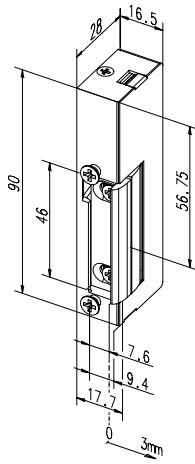

Replacement part 1910E

Door strike small without electric function, with adjustable keeper (FaFix) and with mechanical unlocking.

Technical Attributes

Height	90 mm
Width	16,5 mm
Depth	28 mm

Best. Nr.

1910E-----00

- In preparation for model series 19,119,118

Surface-mounted attachments for model series 14, 24, 34 / 17, 27, 37

For electric strikes with FaFix and dummy components, there is a range of additional surface-mounted attachments available. This allows wide-ranging structural adjustments to be made to frames and locks.

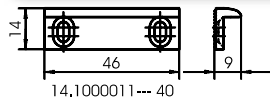
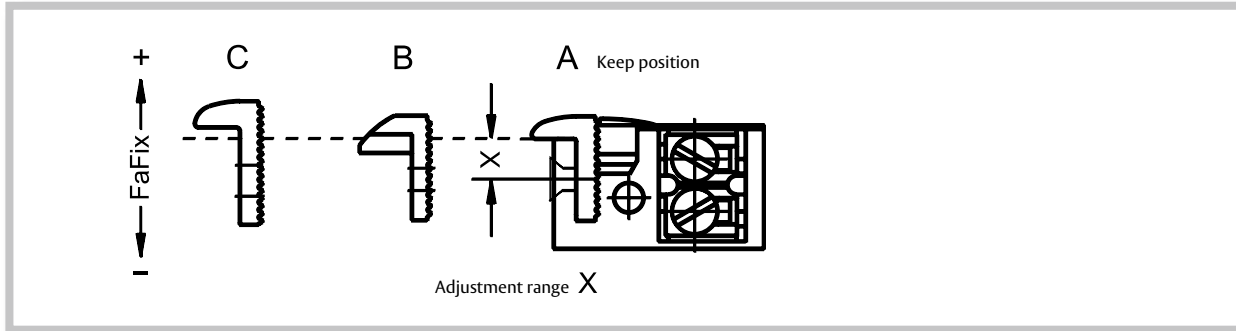

x = 7,6 + 3 mm

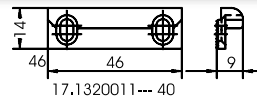

x = 3,1 + 3 mm

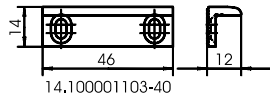

x = 7,6 + 3 mm

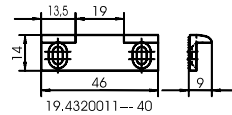

x = 7,6 + 3 mm

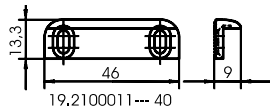

x = 6,6 + 4 mm

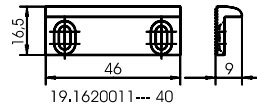

x = 9,1 + 4 mm

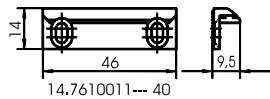

x = 5,7 + 3 mm

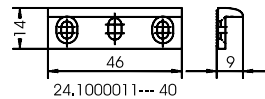

x = 7,6 + 2 mm

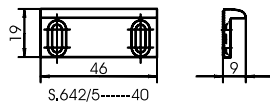

x = 9,1 + 6 mm

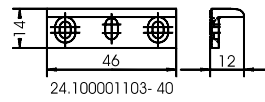

x = 7,6 + 2 mm

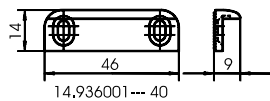

x = 6,6 + 3 mm

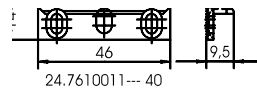

x = 5,7 + 3 mm

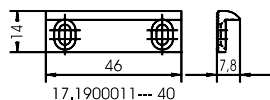

x = 7,6 + 3 mm

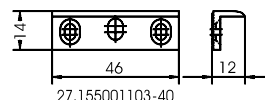

x = 8,6 + 2 mm

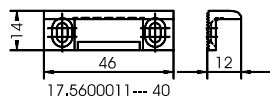

x = 7,6 + 3 mm

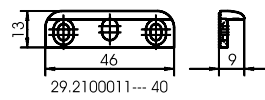

x = 7,6 + 2 mm

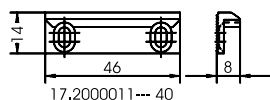

x = 5,7 + 3 mm

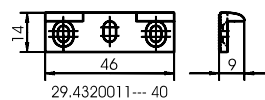

x = 7,6 + 2 mm

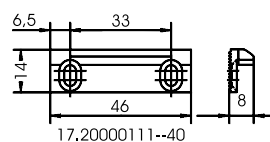

x = 5,7 + 3 mm

Surface-mounted attachments for model series 116, 126, 136

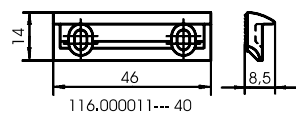
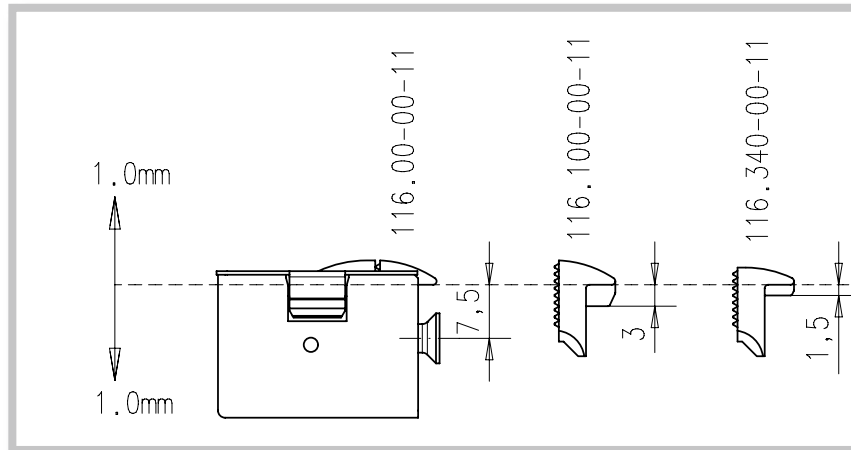

$x = 7,5 \pm 1 \text{ mm}$

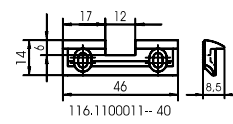

$x = 6,5 \pm 1 \text{ mm}$

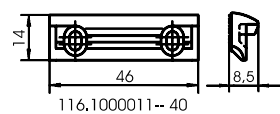

$x = 4,5 \pm 1 \text{ mm}$

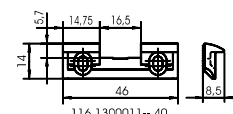

$x = 7,5 \pm 1 \text{ mm}$

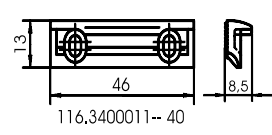

$x = 6,0 \pm 1 \text{ mm}$

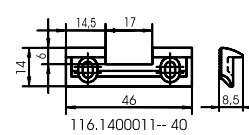

$x = 7,5 \pm 1 \text{ mm}$

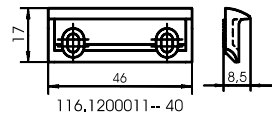

$x = 9,5 \pm 1 \text{ mm}$

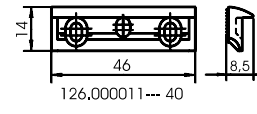

$x = 7,5 \pm 1 \text{ mm}$

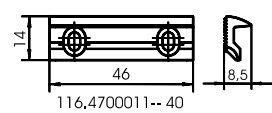

$x = 6,5 \pm 1 \text{ mm}$

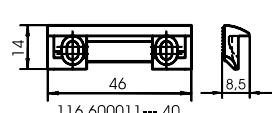

$x = 6,5 \pm 1 \text{ mm}$

Surface-mounted attachments for model 118

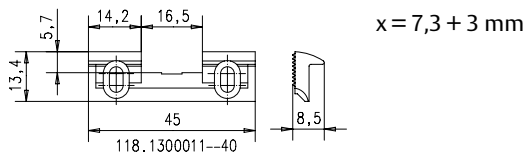
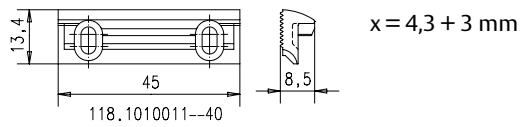
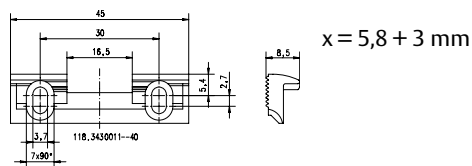
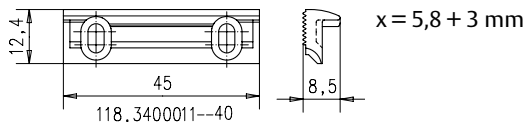
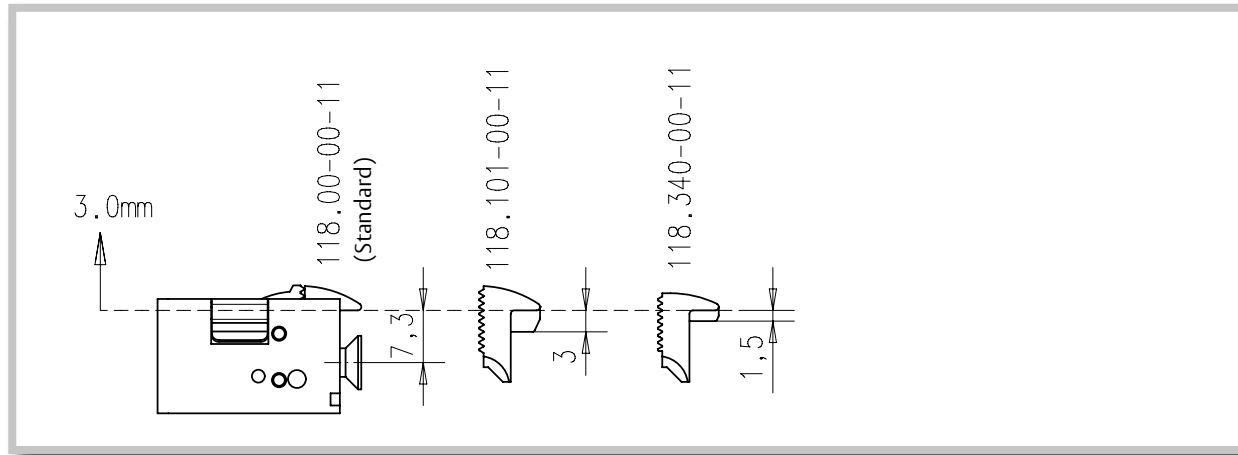

Abbreviations from A to Z

For a better understanding you will find here all relevant abbreviations and the corresponding explanation:

AC	alternating voltage, previously called WS	FF	FaFix indicates adjustment facility of the keep
AK/RR	Monitoring contact in the form of a floating changeover contact. Is actuated by the armature (locking mechanism)	HZ	Long flat striking plate, former designation
DC	Direct voltage, previously called GS	HZF	Long flat striking plate with keep guide, former designation
DL	DIN left	iW	Long angled striking plate, former designation
DR	DIN right	kL	Short flat striking plate, former designation
E	Mechanical unlocking: Strikes with actuating lever in the keep area for mechanical release of the keep. Configured in model series 12 as an adjusting screw.	RR	Monitoring contact as floating changeover contact. Is actuated via a slide by the latch bolt
eE	Permanent electrical unlocking: These strikes are continuous current-proof and are operated with direct voltage, in most cases via timers or switches.	05	Continuous current-proof strikes with recovery diode for 12 V DC access control systems
F	Fix indicates adjustment facility of the strike in the striking plate		

Information on surfaces striking plates

The 11th and 12th digit in the order number designates the surface of the striking plate.

Order no.

126.10-520 **35** ** *

Our striking plates are for the most part offered in stainless steel for quality reasons (35).

If they are not available in stainless steel, further surfaces are:

- 01 gold coloured
- 02 grey
- 40 galvanised

You will find a comprehensive overview of our striking plates range in the separate striking plate catalogue.

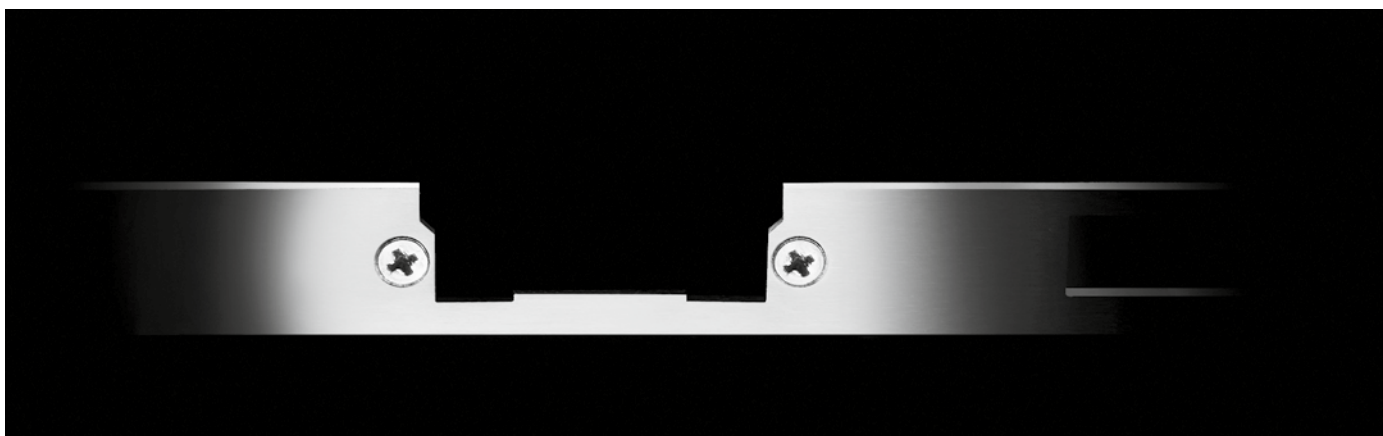

Determination of DIN Direction

Which direction is required?

Rule of thumb:

The door is looked from the side where the hinges are visible. That is the side to which it is opened.
 The DIN-orientation of the electric strike or striking plate refers to the DIN table. For double leaf doors the DIN Direction of the active leaf is decisive.

Order suffix for DIN Direction:

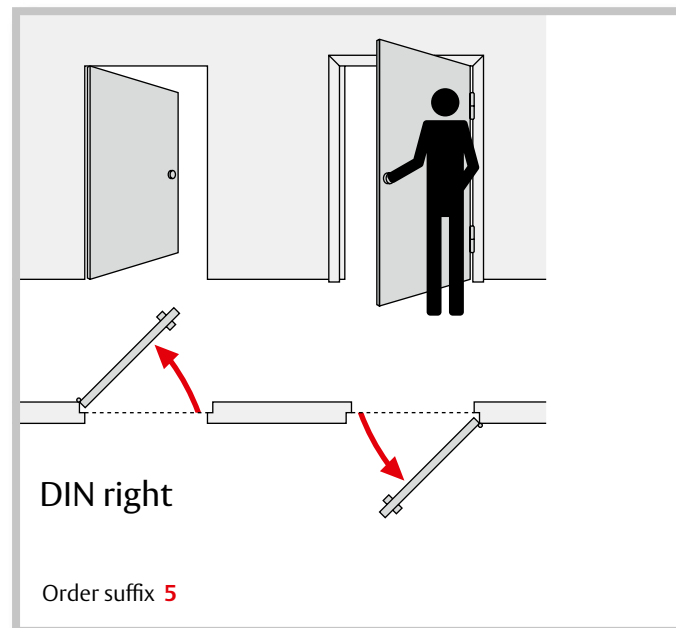
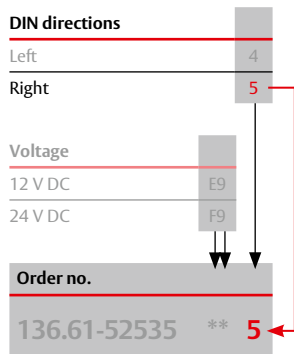
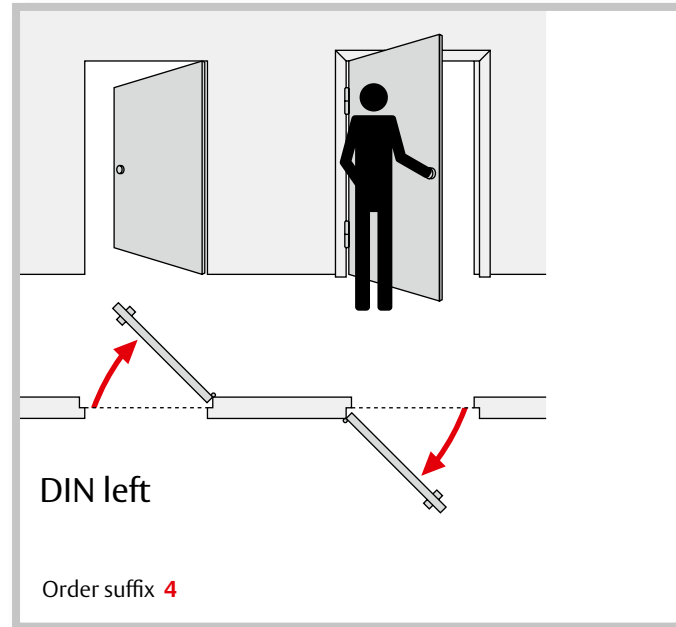
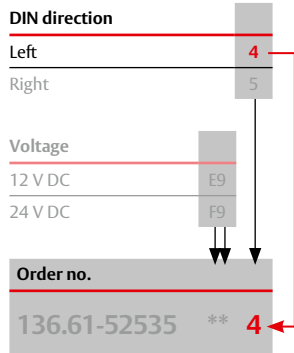

Technical explanations

The Fix and FaFix Function

An important characteristic is the Fix- and the FaFix function in our electric strikes:

Fix Adjustable and fixable electric strikes.
An ideal assistance for electric strike mounting. The screw holes in the striking plate are milled oval. The electric strike casing can be adjusted within them by up to 4mm horizontally after mounting aligned to the latch bolt and fixed in stop grooves. Adjustment and function secure installation even in difficult mounting conditions.

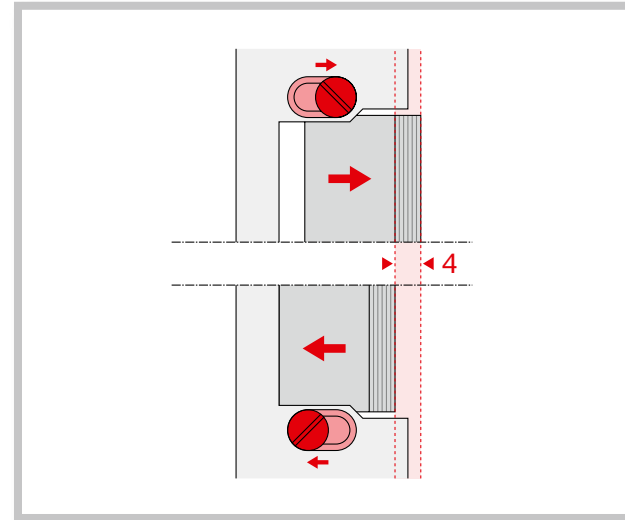

FaFix Door opener with adjustable and fixable electric strike latch bolt:
An ideal assistance for adjusting the latch. Simple mounting, uncomplicated adjustment of the electric strike latch to the latch bolt after installation. It is possible to compensate for expansion at any time by readjusting the door strike. Because of this adjustability, the subsequent adjustment to the latch bolt is possible even in the tightest space constraints.

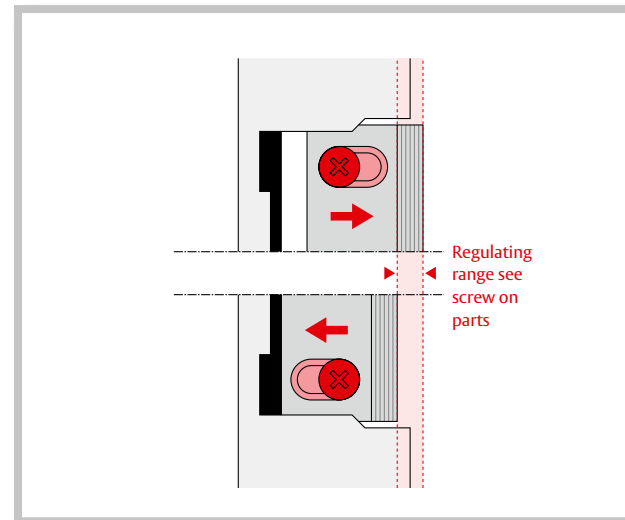

Technical explanations

The ProFix Principle: When ProFix 1, when ProFix 2?

To whom is the ProFix series of interest to?

Do you manufacture essentially functional doors for the property business? But do your customers also get standard doors from you? Then the ProFix series from effeff is just the right one for you!

ProFix can also be of interest for front doors and manufacturers of dividing wall systems.

What is ProFix?

ProFix is a combination consisting of a FaFix electric strike with a latch bolt guide (latch bolt slide) integrated into the electric strike.

To enable the user to take full advantage of radius electric strikes and FaFix in their entirety, effeff has developed ProFix. With ProFix the frame opening/glazed frame cutout can be reduced.

There are ProFix electric strikes for standard doors and also for fire doors use, compatible with a ProFix striking plate. The ProFix escape electric strike Model 332 rounds off the programme.

What to take account of in the choice of electric strike:

When to use ProFix 1 when 2?

The choice between ProFix 1 and ProFix 2 depends on the door/frame construction. Decisive is the so-called "x dimension".

The x – dimension denotes the distance between the front of the door frame and the latch bolt or electric strike latch.

In principle the following applies:

ProFix 1

- from x-Maß 9.4 mm or more
- non-rebated opening door

ProFix 2

- rebated doors with x-dimension 6mm or more (x-dimension 4mm in Model 118)

Illustration shows rebated door

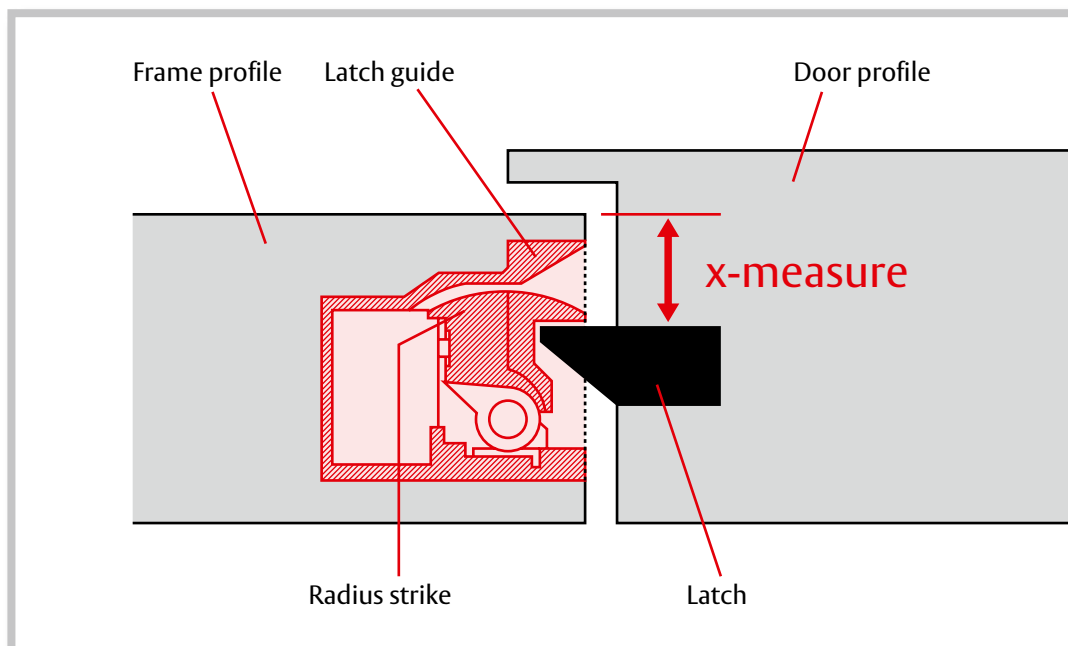

Technical explanations

Suffixes and their meaning

Suffix **RR**
(with model order
number digits 1-7)

Order no.

17**RR**--09635 ** *

RR = Monitoring

The monitoring contact is activated via a slide or actuating plate that is to be found directly behind the engaging edge of the keep by the latch bolt latching into position. The monitoring contact is always configured as a floating changeover contact.

Strikes with monitoring contact are fitted with three additional terminals which are colour coded.

green = n (base contact, common connection)
blue = (normally open contact)
red = (normally closed contact)

Deviating abbreviations are indicated in each case in the provided installation instructions.

Conversely to other types of monitoring contacts such as magnetic or taper contacts, the special position of the monitoring contact in the strike means that it indicates with absolute precision that the door is closed and the latch bolt in place. Monitoring contacts are required in the main in access control systems. The monitoring contact signals the door status "open" or "shut". The access control system evaluates this information and monitors the door.

If, for example, a door is not closed after being passed through the access control system initiates an alarm. The application of current to the strike is terminated when the door is opened so that, when the door is closed, it is immediately locked again. Signals to alarm systems, building management systems etc. are also implemented by means of monitoring contacts. Monitoring contacts are ideally suited for the creation of interlock systems using strikes.

The condition for optimum functioning is correct positioning of the latch bolt in the keep.

In order to guarantee the necessary actuating path of the slide or the actuating plate, the latch bolt must penetrate completely into the keep.

(Switching output 24 V/1 A ohmic load).

Technical explanations

The electrical and technical details in the tables and their meaning

Explanation to the tables:
“Electrical data”

Rated operating voltage tolerance range:

Within the specific tolerance range, the strike operates with absolute functional reliability and complies with the given specifications. When planning, always take into account that the operating voltage must be applied to the strike terminals.

A voltage loss (voltage drop) takes place between the transformer and the strike during strike operation, which in the case of long conductors with a low cross-section, can result in a drop below the specified operating voltage despite the fact that the rated voltage of the transformer is in agreement with the stated

operating voltage range of the strike.

A drop below operating voltage also occurs in the case of transformers or power supply units with a specified rated current below the current consumption of the selected electric strike. If a drop below operating voltage occurs, operation is no longer possible. When dimensioning conductor cross-sections, transformers, power supply units and also when selecting a suitable strike, our technical support service will be pleased to assist you.

The various rated operating voltages and when they are used

These models are designed for brief operation (max. 5 secs) for direct and alternating voltage.

These strikes must not be permanently connected to electrical current. In brief operation, the operating voltage may not be exceeded by more than 50%.

A7	=	10-24 V AC/DC
B7	=	22-42 V AC/DC
D1	=	6-12 V AC/DC
R1	=	8-16 V AC/DC
F1	=	24 V AC/DC

These models are designed for permanent operation with direct voltage. They permit a door to be permanently unlocked over long periods. Operating with alternating voltage, which will result in a humming noise, is also possible. In brief operation, the operating voltage may not be exceeded by more than 50%.

E3	=	12 V eE
F3	=	24 V eE

These models are designed for permanent operation with direct voltage. They permit a door to be permanently unlocked over long periods. Operating with alternating voltage is not possible. In brief operation, the operating voltage may not be exceeded by more than 50%.

E4	=	12 V 100% ED
F4	=	24 V 100% ED

These models are designed for standby current operation with direct voltage. Operating with alternating voltage is not possible.

E9	=	12 V DC
F9	=	24 V DC

Order no.

1705--02135 ** *

The suffix “05” within the order number (1st to 7th digit) describes a protection diode that is parallel switched to the solenoid protecting the electronics from overload. These models can only be operated with DC and can be used in conjunction with E3 and E4 voltages.

xx05 Modelle = 12 V DC Access control systems

Technical explanations

The electrical and technical details in the tables and their meaning

Pre-load/keep preload indication in Newton (N)

Due to door seals, door geometries, unfavourable mounting conditions and differences in air pressure existing on the inside and outside of the door leaf the latch bolt exerts a force on the keep. The electrical unlocking property of the strike is guaranteed up to the specified value. The specified values have been determined under laboratory conditions and are used for comparison of the strike models and as an aid to selection of the most suitable model. Depending on the

door geometry and the lock used, the values determined at the door leaf can vary when the strike is mounted. Specifically where large forces (pre-load) are involved, the model series 131 and 331 offer reliable function.

Explanation to the tables:
"Technical data"

Resistance to forced entry:

This specification defines the stability of the strike. This value also plays a determining role in selecting the most suitable electric strike where heavy-duty doors and doors with a high frequency of through traffic are involved.

Operating temperature range:

The strike is guaranteed to function within this range. Please note, however, that other ambient conditions such as the condensation in case of marked fluctuations in temperature and high humidity as well as freezing of the strike can exert an impeding effect on the function of the strike.

Operating noise (see table):

The specified values have been determined under laboratory conditions (measured in 30cm intervals) and are used for comparison of the strike models. These values can vary depending on the materials and the mounting situation.

Mounting independent of position:

Strikes can be mounted, vertically, horizontally or turned by 180°. With horizontal mounting, the strike must be mounted on the lock side in order to avoid unfavourable levering effects. Mounting in the floor area is not admissible. Strikes for fire doors may only be used in the correct position as illustrated in order to guarantee reliable holding even in case of fire.

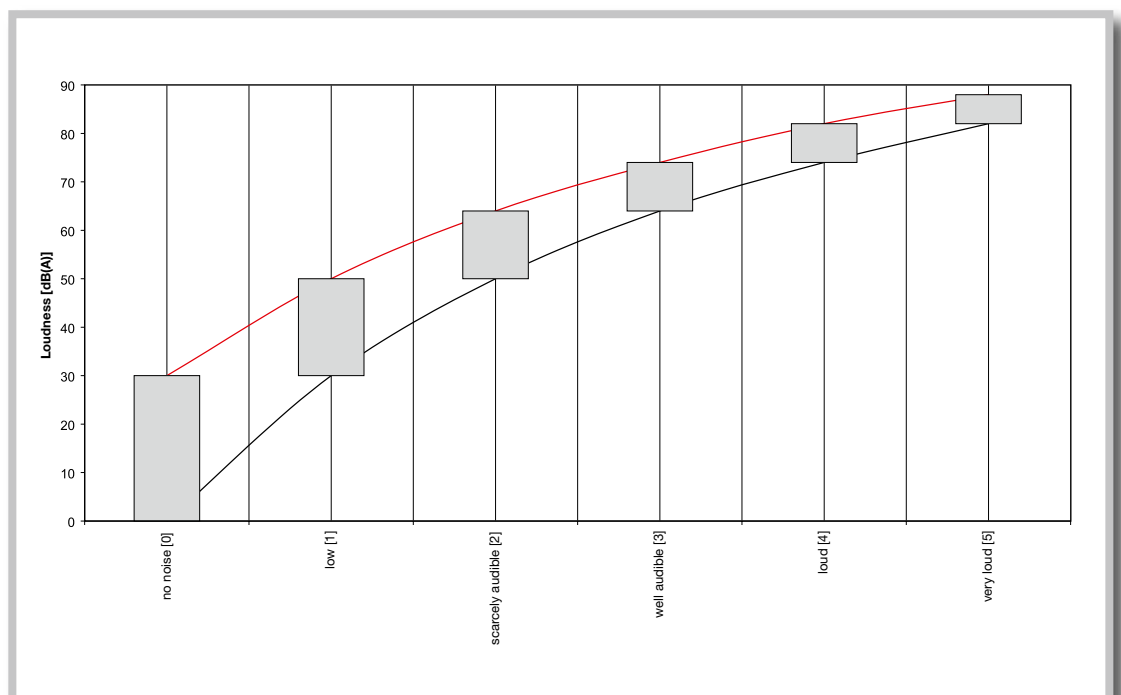

Order Form

Please copy formular, complete and fax it back to ASSA ABLOY!

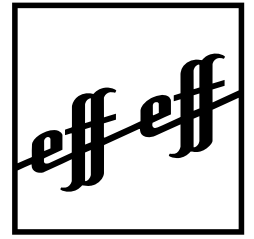

ASSA ABLOY

ASSA ABLOY
Sicherheitstechnik GmbH
Bildstockstraße 20
72458 Albstadt
GERMANY
Tel. +49 7431 123-700
Fax +49 7431 123-258
export@assaabloy.de

Customer-Nr.:

Address:

Company

Branch

Contact

Telephone

Fax

Email

Street / POB

Postal Code / Town

Order Date:

Order Number	Pce.

Urgent orders can also
be placed via email.

As a proven supplier of door release systems, effeff is known for reliable and prompt deliveries. We offer you two methods of ordering: You can fax us the completed form or send us details of your requirements via email to the following address: **export@assaabloy.de**

Quotations and deliveries are made in accordance with our conditions of delivery and payment.

Goods return form

Please copy formular,
complete and fax it back to
ASSA ABLOY!

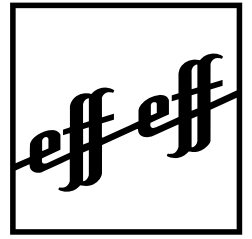

ASSA ABLOY

Customer-Nr.: _____

Address: _____

Date: _____

ASSA ABLOY
Sicherheitstechnik GmbH
Bildstockstraße 20
72458 Albstadt
GERMANY
Tel. +49 7431 123-700
Fax +49 7431 123-258
export@assaabloy.de

We wish to make the
following return of goods:

Invoice No. / Date	Order No.	Quantity

Please note:

Goods may only be returned if they are new, packed originally and without any marks of usage and installation. They should be returned within 6 months of purchasing (date of dispatch).

Reasons for return

- Incorrect order
- Incorrect delivery
- Exchange
- Complaint
- Other

ASSA ABLOY
Sicherheitstechnik
offers the following
options:

- Return with ____ % deduction
- Re-order free of charge
- Replacement delivery
- We regret these goods cannot be returned
- Other

Date Customer's signatur

Date Signatur
ASSA ABLOY Sicherheitstechnik

Note:

Please ensure that this letter accompanies the returned goods. The consignment will be returned carriage forward unless accompanied by a returns note with notice of prepayment. If you have any queries on matters in progress, please telephone +49 7431 123-700 or fax -258.

In the future we'll also meet the demands for technical advances and innovations. We therefore reserve the right to make design modifications.

Illustrations may thus also vary from the actual products. Despite the greatest of care, printing errors or mistakes may be made.

ASSA ABLOY accepts no responsibility in such cases and will not enter into any obligations of any kind. No responsibility is taken for the correctness of any safety regulations reproduced.

ASSA ABLOY is the global leader in door opening solutions, dedicated to satisfying end-user needs for security, safety and convenience.



Originally part of the ZEISS IKON AG company founded in 1926, **IKON** is ASSA ABLOY's most successful brand for locking and security technology in Germany. The IKON brand offers state-of-the-art products and solutions at the cutting edge of technology. The brand product range includes high-quality mechanical and mechatronic locking cylinders, auxiliary locks and security devices, door fittings and door closers. They provide active burglary protection and safeguard both people and property.



Founded as a precision engineering and electrical engineering workshop in 1936, **effeff** is a global leading brand for electromechanical locking and unlocking devices. Electric strikes, electric bolts, security locks, access control systems and escape route technology are among the effeff brand products which today provide security and convenience in over 75 countries throughout the world.

ASSA ABLOY Sicherheitstechnik GmbH is the professional partner worldwide in mechanical and electromechanical security solutions for safety, security and convenience in buildings. The company develops, produces and markets high-quality products and multi-purpose systems under the established IKON and effeff brand names for the private, commercial and public sectors.

ASSA ABLOY is the world's leading manufacturer and supplier of door opening solutions, meeting tough enduser demands for safety, security and convenience. With over 32,000 employees, the Group achieves sales of over EUR 3.5 billion.

ASSA ABLOY
Sicherheitstechnik GmbH
Bildstockstraße 20
72458 Albstadt
GERMANY
albstadt@assaabloy.de
Tel. +497431 123-700
Fax +497431 123-258
www.assaabloy.de